

SHARP



Operating Instructions

LED TV with Freeview HD

Image for illustration purposes only. Actual product may vary.

IMPORTANT GUARANTEE INFORMATION

Congratulations on purchasing this television. We hope you have many years of trouble free enjoyment from your purchase.

Your product is covered under the manufacturers guarantee for 12 months from the date of purchase.

If you experience any difficulties with your TV, please refer to the 'Frequently asked questions' section at the rear of this user guide.

If you are still unable to remedy the issue, try resetting the TV to factory settings - details can be found in the 'Settings' menu section of this user guide - alternatively, please contact the helpline.

In the event that a fault is diagnosed, the helpline will arrange to collect the TV from your home or work address, return it to our service centre, repair the item and then return it to you.

If we believe we cannot offer a permanent repair, we will replace the item.

Technical Support Information

Telephone UK 0330 024 0803, ROI 01443 3323

Web support: www.umc-uk.co.uk

Email: service@umc-uk.co.uk

Calls to 0330 numbers are charged at standard call rates and are included as part of any bundled minutes with your phone provider.

The telephone opening hours are Monday to Friday 8.30am to 6pm, Saturday 9am – 5pm.

UK: Calls are charged at your normal telephone call rate.

ROI: Calls are charged at a local rate.

Please retain all packaging materials, in addition to your proof of purchase/receipt, as you will need these in the event of warranty/service support.

This guarantee is in addition to and does not affect your statutory rights.

If you need to call the helpline, you will need the following information.

1) Model No _____ (You can find this on the rear of the TV)

2) Date of purchase _____ (You can find this on your sales receipt)

3) Serial Number _____ (You can find this on the rear of the TV)

EXAMPLE OF LABEL ON REAR OF TV

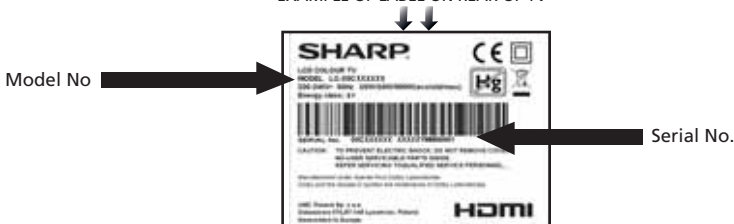

This TV set is for domestic use only

Important Safety Instructions



Please read these instructions. All of the safety and operating instructions should be read before the appliance is operated.

Warnings

- Television sets with 40" screens or larger must be lifted and carried by at least 2 people.
- This television does not contain any parts that are serviceable by the user. In the event of a fault, contact the manufacturer or authorised service department.
- Exposing the internal parts of the TV may endanger your life. The manufacturer's guarantee does not extend to faults caused by repairs carried out by unauthorised third parties.

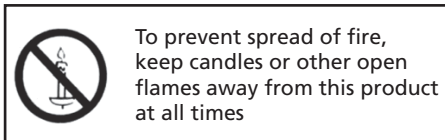

- Do not use the TV set immediately after unpacking. Wait until the TV warms up to room temperature before using it.
- To reduce the risk of fire, electric shock or damage to the TV, do not expose it to dust, rain or moisture. Never expose the TV to dripping or splashing and do not place objects filled with liquids on or near the TV.
- Do not connect any external devices (DVD player, games console etc) when the TV is switched on. Disconnect both the TV and device from the mains before connecting. Only switch appliances on when the connection process is complete.
- Do not place the television in a confined space and do not obstruct the ventilation openings at the rear of the television.
- When installing on a wall, ensure the TV is at least 5cm from the wall for ventilation.
- Always ensure that the TV's ventilation openings are not covered with items such as newspapers, tablecloths, curtains, etc.
- Dispose of this television and any components including batteries in an environmentally friendly manner. If in doubt, please contact your local authority for details of recycling.
- Ensure this TV is used in moderate climates only.
- In case of electrostatic discharge (ESD) the TV may operate incorrectly. If this happens, turn the set off at the mains and then turn back on again after 30 seconds. The set should now work normally.

WARNING: Never place a television set on an unstable location. The TV set may fall causing serious personal injury or death. Many injuries, particularly to children, can be avoided by taking simple precautions such as:

- Use cabinets or stands recommended by the manufacturer of the television set.
- Only use furniture that can safely support the television set.
- Ensure the television set is not overhanging the edge of the supporting furniture.
- Do not place the television set on tall furniture (for example, cupboards or bookcases) without anchoring both the furniture and the television set to a suitable support.
- Do not place the television set on cloth or other materials that may be located between the television set and supporting furniture.
- Please educate children about the dangers of climbing on furniture to reach the television set or its controls.
- If your existing television set is being retained and relocated, the same considerations as above should be applied.

Safety

- For your safety, this appliance is fitted with a fused 3 pin mains plug. Should the fuse need to be replaced, ensure that any replacement is of the same amperage and approved with the BSI mark.
- Never try and replace the mains plug unless you have adequate qualifications and are legally authorised to do so. In the event that a replacement mains cable is required, contact the manufacturer for a suitable replacement.
- Never use the television if it is damaged in any way.
- Always place the television on a flat level surface avoiding anywhere which may be subject to strong vibration.
- The ideal distance to watch the television is approximately five times the length of the diagonal measurements of the TV screen.
- Ensure the television is not placed on top of the power cable as the weight of the television may damage the cable and cause a safety hazard.
- Never place mobile phones, speakers or any other device which may cause magnetic or radio interference, near the television. If interference is apparent, move the device causing the interference away from the television.
- To disconnect the set from the mains, remove the mains plug from the socket.
- Ensure that the mains plug is always easily accessible.
- When handling the set do not grip the LCD Panel.
- Do not pull the set when mounted on a bracket. If using a moveable bracket, adjust via the bracket and not the TV set.
- Do not place this set above a heat source.

WARNING: Excessive volume when using earphones and headphones can cause loss of hearing.

Important Safety Instructions



Maintenance

- To clean your TV, wipe with a soft, dry cloth. If the surfaces are extremely dirty, use a soft cloth dipped in a soap and water solution or a weak detergent solution.
- Never use alcohol, paint thinner or benzene to clean this unit.
- Before using a chemically treated cloth, read the instructions that came with the cloth carefully.

CAUTION: If water or other liquid enters the television through the display panel surface, a malfunction may occur.



Packaging

- The safest way to transport your item is in the original box/packaging - please save your packaging for this.
- You will need the original box/packaging in the event of warranty/service repair or support. We are unable to carry out warranty/service if you are unable to package the item correctly.

Important information regarding use of video games, computers, captions or other fixed image displays

The extended use of fixed image program material can cause a permanent "shadow image" on the LCD/LED panel, also known as "screen burn".

This "shadow image" can appear in the background during normal viewing. This type of irreversible LCD/LED panel deterioration can be limited by observing the following steps:

1. Reduce the brightness/contrast setting to a minimum suitable viewing level.
2. Do not display the fixed image for extended periods of time.
3. Turn the power off when not in use.

Examples of images that are more likely to cause "screen burn" are as follows (this is not an exhaustive list):

- TV channel logos: e.g. shopping channel logos and pricing displays - especially if they are bright and stationary. Moving or low-contrast graphics are less likely to cause ageing of the screen.
- Time displays.
- Teletext: Do not view a static page for a long period of time
- TV/DVD menus: e.g. listings of DVD disc content.
- Pause mode: Do not leave the TV in pause mode for long periods of time, e.g. when watching DVDs or videos.

Important: Once 'shadow image/screen burn' occurs, it will never disappear and is not repairable under warranty.

How do I dispose of this product?

UK: Waste electrical products should not be disposed of with household waste. Please dispose of the product at a designated collection point for recycling of WEEE. For your nearest facilities, please see www.recycling-more.co.uk or in store for details.



ROI: Waste electrical products should not be disposed of with household waste. Separate disposal facilities exist. Check with your local authority or retailer for recycling advice.



Batteries

- Do not expose batteries to high temperatures, excessive heat, prolonged sunshine or fire as this may cause leakage, explosion or ignition.
- Observe the correct polarity when inserting batteries.
- Do not use different types of batteries together or mix old and new batteries.
- Dispose of batteries in an environmentally friendly way.
- Certain regions may regulate the disposal of batteries. Please consult your local authority.

Caution

- Appliances with built in DVD player are marked with this caution label
- THIS UNIT IS A CLASS 1 LASER PRODUCT. THIS UNIT USES A VISIBLE LASER BEAM WHICH COULD CAUSE HAZARDOUS RADIATION EXPOSURE IF DIRECTED. BE SURE TO OPERATE THE PLAYER CORRECTLY AS INSTRUCTED WHEN THIS UNIT IS PLUGGED INTO THE WALL OUTLET, DO NOT PLACE YOUR EYES CLOSE TO THE OPENINGS TO LOOK INTO THE INSIDE OF THIS UNIT.
- USE OF CONTROLS OR ADJUSTMENTS OR PERFORMANCE OF PROCEDURES OTHER THAN THOSE SPECIFIED HEREIN MAY RESULT IN HAZARDOUS RADIATION EXPOSURE.
- DO NOT OPEN COVERS AND DO NOT REPAIR YOURSELF. REFER SERVICING TO QUALIFIED PERSONNEL.



CE Statement:

Hereby, UMC Poland Sp. z o.o. declares that this LED TV is in compliance with the essential requirements and other relevant provisions of RED Directive 2014/53/EU.

<http://www.sharp.eu/av/documents-of-conformity>

Trademarks

HDMI

The terms HDMI and HDMI High-Definition Multimedia Interface, and the HDMI Logo are trademarks or registered trademarks of HDMI Licensing, LLC in the United States and other countries.



The "HD TV" Logo is a trademark of DIGITALEUROPE.



The "HD TV 1080p" Logo is a trademark of DIGITALEUROPE.



The DVB logo is the registered trademark of the Digital Video Broadcasting (DVB) project.



The FREEVIEW text and logos are trademarks of DTV Services LTD. © DTV Services Ltd



SAORVIEW is a registered trademark owned by RTÉ.



Manufactured under license from Dolby Laboratories. Dolby, Dolby Audio and the double-D symbol are trademarks of Dolby Laboratories.



The "CI plus" Logo is a trademark of CI Plus LLP.



For DTS patents, see <http://patents.dts.com>. Manufactured under license from DTS Licensing Limited. DTS, the Symbol, & DTS and the Symbol together are registered trademarks. DTS TruSurround is a trademark of DTS, Inc. © DTS, Inc. All Rights Reserved.

CONTENTS

Manufacturers Guarantee Information	3
Important Safety Instructions	4-5
Trademarks	6
Securing the TV to a Wall/Wall Mounting	8
TV Buttons and Input Source Menu	9
TV Control Stick and Input Source Menu	10
Connections	11-15
7 Day TV Guide and Channel List	16
TV Menu Operation	17-25
Picture Menu	17-18
Sound Menu	19-20
Channel Menu	21-22
Settings Menu/Setup	23-25
Network Menu	24
Lock Menu	24
Time Menu	25
Setup	25
USB Mode/Media Player	26
DVD Setup Menu	27
USB Record/PVR-Freeview/Saorview Mode	28-29
General Information	30-32
Frequently Asked Questions	30-31
Compatible File Types For USB Playback	32

SECURING THE TV TO A WALL

Securing the TV to a wall with anti-tip straps

For maximum security in the home, when using a TV with its stand, anti-tip straps should be fitted. These are available from major retailers & websites and are an easy, inexpensive and effective way of ensuring your TV stays safely upright. Straps are designed to be attached to the rear of the TV and then tethered to the wall or the furniture the TV is stood on, these are fitted as follows.

A) Using one or both of the top wall-mounting holes and screws fasten one end of the fastening cord/s to the TV. (the screws are already supplied in the wall mounting holes)

B) Secure the other end of the fastening cord/s to your wall. (you will need screws/fixings suitable for your wall type - available separately from most DIY stores).

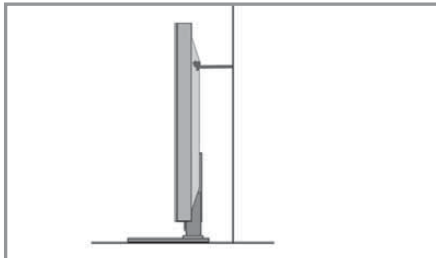
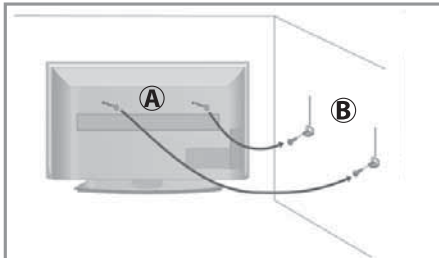

Note: Please ensure that children do not climb on the TV set.

Note: When handling the set do not grip the LCD Panel.

Note: Do not pull the set when mounted on a bracket. If using a moveable bracket, adjust via the bracket and not the set.

The Royal Society for the Prevention of Accidents is urging people to take care with flat-screen televisions.

RoSPA stated in 2010 that "Toddlers are particularly at risk of pulling flat-screen televisions on to themselves. They are unsteady on their feet and are attracted by colourful television images."

The risk is increased as televisions become lighter.

Wall mounting

IMPORTANT - Before drilling any holes in the wall ensure you are not drilling where there could be electrical wires, water or gas pipes.

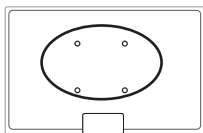

1) Remove the four screws located at the back of the TV set.

2) The wall mount can now be easily attached to the mounting holes, located on the back of the TV, using the same four screws removed.

For optimum viewing, if wall mounting the TV higher than eye level, the TV should be tilted downwards so that the TV's screen is 'face on'. See fig 1 and 2.

fig 1 INCORRECT

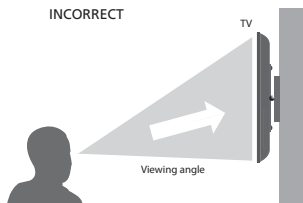
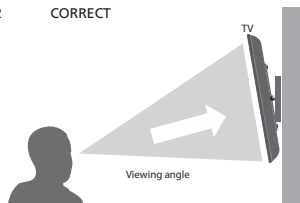

fig 2 CORRECT



Important – If wall mounting this TV, only use the screws already provided in the wall mounting holes. Using other screws which are longer could cause irreparable damage to internal parts. When using a wall bracket, please ensure the screws in the back of the TV set are not over tightened.

TV BUTTONS AND INPUT SOURCE MENU

For models with buttons on the side/underside/rear of the TV

Button layout and shape may vary.



Standby	Power On/Off
Source	Input Source Menu
Menu	Menu/OSD
CH-	Programme/Channel down and menu down
CH+	Programme/Channel up and menu up
Vol-	Volume down and menu left
Vol+	Volume up and menu right

Models with built in DVD players will include additional buttons:



▶▶	Play/Pause Disc
▲	Stop/Eject Disc

Choosing Mode Input/Source

To switch between the different inputs or connections

For further information on Inputs and connections refer to the 'Connections' pages.

A) Using the buttons on the remote control:

- 1) Press [SOURCE] - The source menu will appear.
- 2) Press [V] or [A] to select the Input you require.
- 3) Press [OK].

B) Using the buttons on the Television:

- 1) Press [SOURCE].
- 2) Scroll up/down using CH+/ CH- buttons to the input/source you require.
- 3) Press Vol+ to change input/source to the one selected.



An example of the 'Input Source' menu (will vary by model)

TV CONTROL STICK AND INPUT SOURCE MENU

For models with the joystick type controller.



Control Stick



DVD Buttons



An example of the 'Input Source' menu
(will vary by model)

TV Control Stick

The TV control stick is located on the back of the TV. The control stick can be used to control many of the TV's functions. The shape of the TV's control stick may vary by model.

While TV is in standby mode:

- Press the centre of the control stick once - Power on the TV set

While watching TV:

- RIGHT/LEFT – volume up/volume down
- UP/DOWN – changes channel up/down
- Press the centre of the control stick once – displays the menu
- Press the control stick UP (or DOWN) for a few seconds to enter the Source menu.
- Press and hold the centre of the control stick – Standby/Power Off

While in menu:

- RIGHT/LEFT/UP/DOWN – navigation of cursor in on-screen menus
- Press the centre of the control stick once – OK/Confirm selected item
- Press and hold the centre of the control stick – back to previous menu

DVD Buttons (Only applies if the TV has an in-built DVD player)

The DVD buttons are located on the side of the TV near the DVD Slot.

- TOP BUTTON – STOP/EJECT (Hold down for 4 seconds to eject a DVD).
- BOTTOM BUTTON – PLAY/PAUSE.

Choosing Mode Input/Source

Use the source menu to switch between input/connections.

A) Using the buttons on the remote control:

1. Press [SOURCE] - The source menu will appear.
2. Press [A] or [V] to select the input you require.
3. Press [OK].

B) Using the TV control stick:

1. Press the control stick UP (or DOWN) for few seconds to enter the Source menu.
2. Press the control stick up/down to scroll through and select the input/source you require.
3. Press the centre of the control stick to select the chosen input/source option highlighted.

For further information on input/connections please view the 'Connections' pages

CONNECTIONS

Note: The TV input/output connections and connecting cables on these pages are shown for reference . Cables are available separately from your retailer. **Not all connections are available on all TV models.**

Connecting to a device with Composite AV/Video output

TV source should be set to Composite/AV

Connection example TV models with Mini-AV input

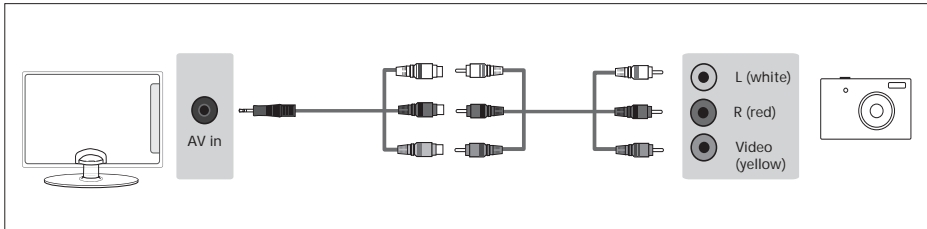

Connection example for TV models with AV input

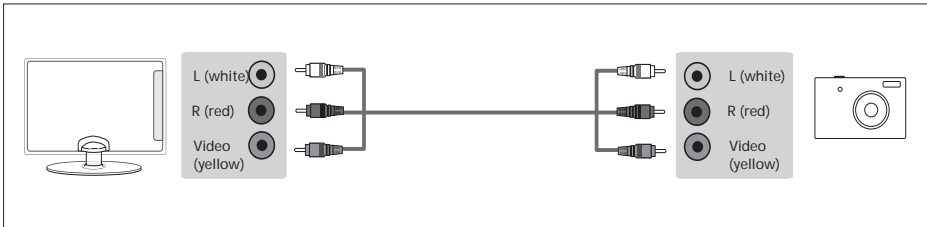

Connecting to a device with SCART output

TV source should be set to SCART

Connection example for TV models with SCART input

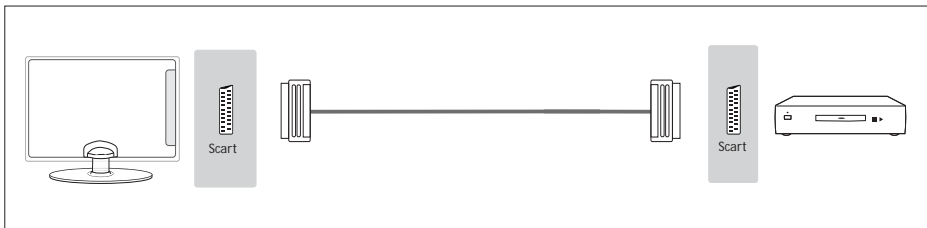

Connection example for TV models with Mini-AV input (1)

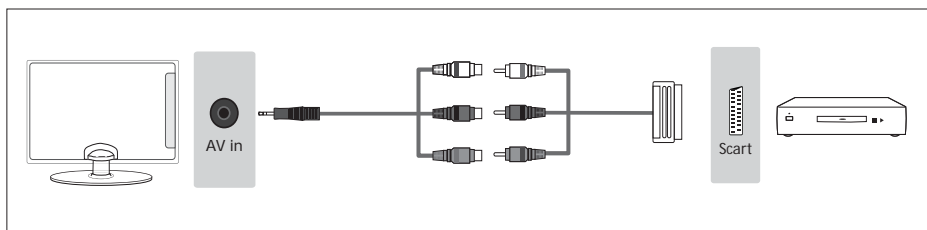

CONNECTIONS

Connection example for TV models with Mini-AV input (2)

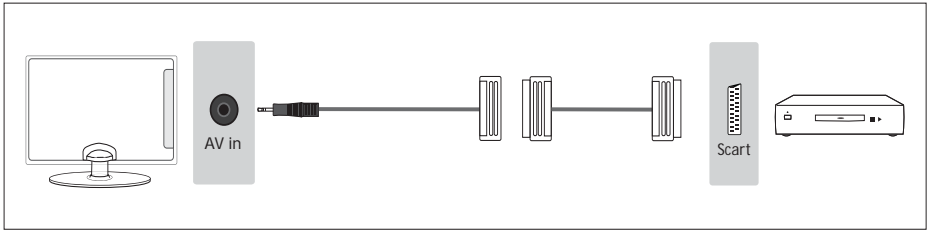

Connection example for TV models with L/R Audio and Video inputs

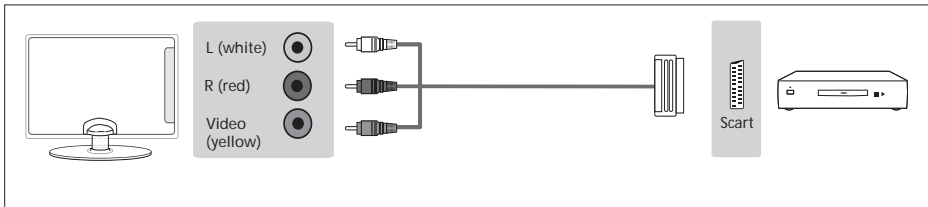

Connecting to a device with Component/YPbPr output

If you are supplied with a cable from the device which has RED, GREEN, BLUE, RED & WHITE connectors you must connect via Component (for picture) and by phono cable (for sound). TV source should be set to Component/YPbPr

Connection example for TV models with Mini-YPbPr and Mini-AV inputs

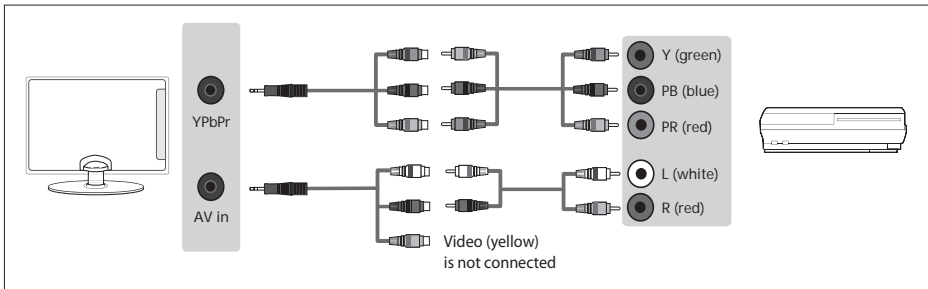

Connection example for TV models with Mini-YPbPr and L/R audio inputs

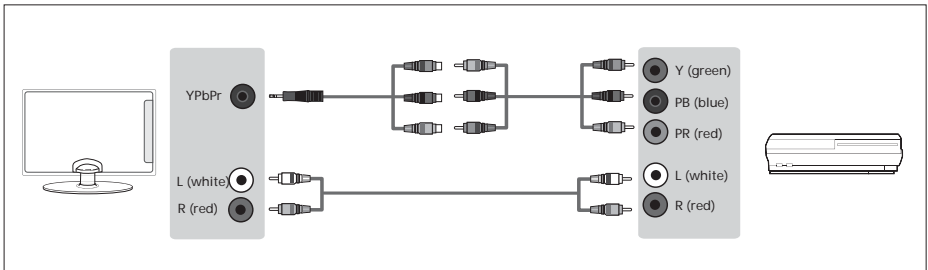

CONNECTIONS

Connection example for TV models with YPbPr and L/R Audio inputs

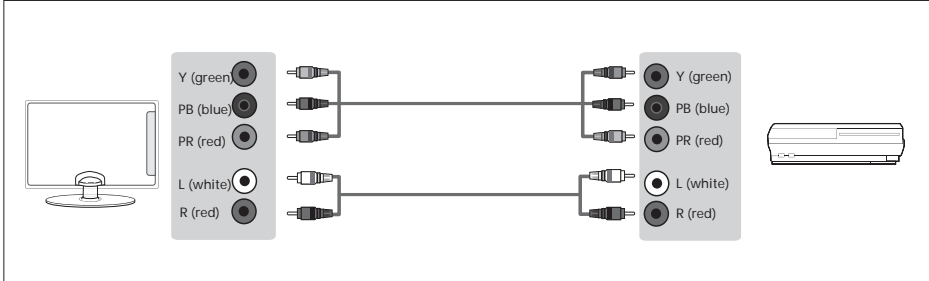

Connection example for TV models with YPbPr and Mini-AV inputs

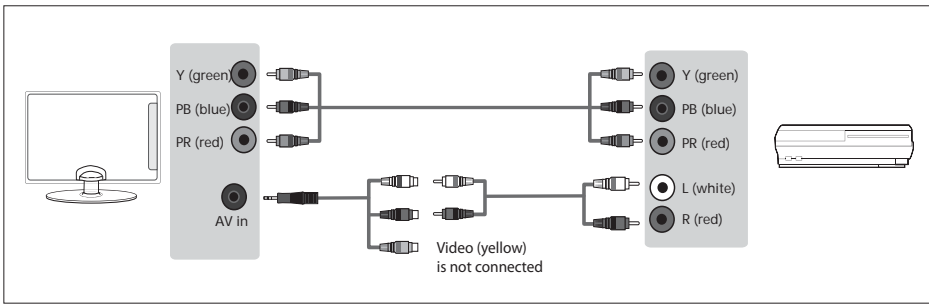

Connecting to an external audio device (Amplifier, Surround Sound, Sound Bars etc)

When connecting via the TV's 3.5mm earphone output, this will disable the TV speakers.

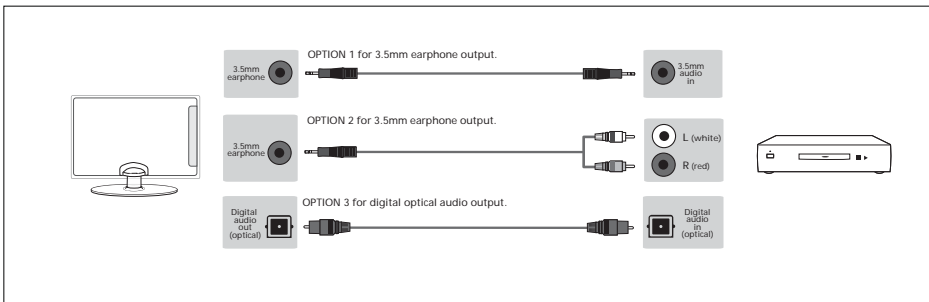

Note: When connecting an external audio device to the TV, set the TV volume to a higher than normal level, you will then be able to use your device remote control to adjust the volume of the connected device to suit your requirements.

CONNECTIONS

Connecting to a device with HDMI output

A HDMI cable can output both video and audio and enables you to enjoy digital-quality video and audio with minimal loss of quality.
TV source should be set to the corresponding HDMI port (HDMI 1, HDMI 2 etc)



Connecting to a device with RF output (CCTV or other Analogue devices)

TV source should be set to ATV/Analogue TV.
Note: You will need to manually tune your device into an analogue channel.

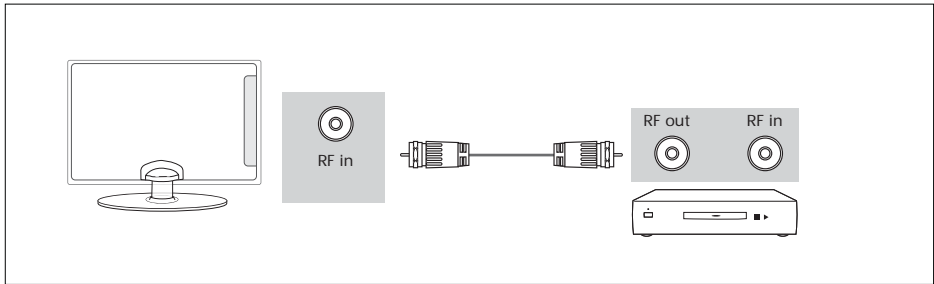

Connecting an Ethernet/Network cable

The Ethernet port is used only for Pay TV services and Freeview HD (Freeview services are only available in the UK). It is not intended for internet use.

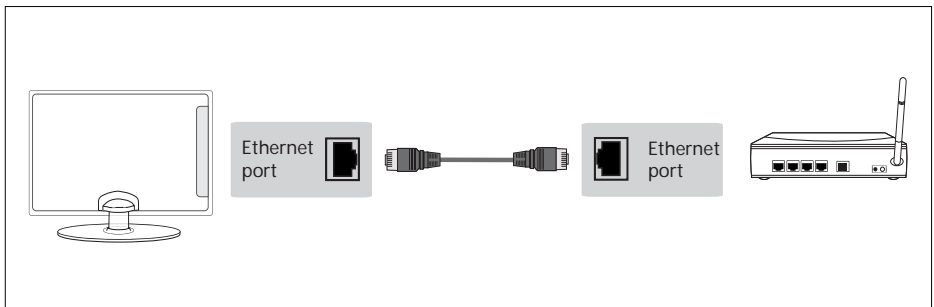

CONNECTIONS

Connecting to a USB device

To use the USB input, TV source should be set to USB Media.

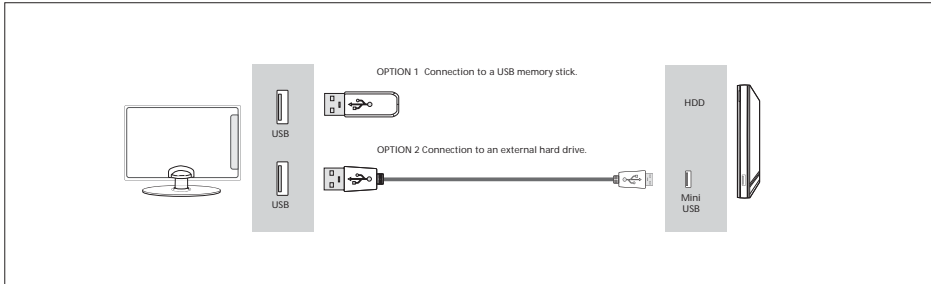

Note: Tablets and/or phones can be charged via the USB port, however, it's not possible to play back media from these devices.

Note: Some USB devices may need to be connected to an external power supply before being used with this input, i.e. powered hard drive.

Connecting the TV to Earphones

When connecting via the TV's 3.5mm earphone output, this will disable the TV speakers.

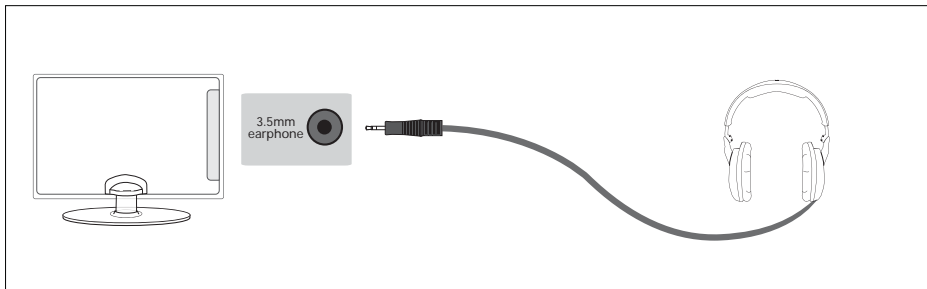

7 DAY TV GUIDE AND CHANNEL LIST

TV Guide is available in Saorview/Freeview TV mode. It provides information about forthcoming programmes (where supported by the Saorview/Freeview channel). You can view the start and end time of all programmes and on all channels for the next 7 days and set reminders.

1) Press the [TV GUIDE] button on the remote control and the following 7 Day TV Guide will appear:



Note: Freeview HD channels found during tuning will be placed in channel positions above 100, for example, 101 - BBC 1 HD, 102 - BBC 2 HD etc.

2) Navigate through the menu using ▲▼▶◀.

You can now:

Press [GREEN] on a highlighted programme to set a reminder:

- **Select Remind Once** (🕒) - reminder will only occur for this one programme at the time selected.
- **Select Daily Reminder** (🕒) - reminder will occur every day at this time
- **Select Weekly Reminder** (🕒) - reminder will happen every WEEK, on this day and at this time.

Press [YELLOW] to view a previous day's list of programmes.

Press [BLUE] to view the next day's list of programmes.

Press [RED] on a highlighted programme to use the record function. (Function for USB Record/PVR models only, USB device must be connected):

- **Record a programme once** (🕒) - press the [RED] button once.
- **Set up a daily recording** (🕒) - press the [RED] button twice, a recording will occur daily at this time.
- **Set up a weekly recording** (🕒) - press the [RED] button three times, recording will happen every week, on this day and at this time.

Press [INFO] to view further information about the programme highlighted.

3) Press [EXIT] to exit the 7 day TV Guide

Note: Record functions are only applicable to sets with a built in USB Record/PVR function.

Note: When the TV set is on, a reminder message will be displayed informing you that a programme is about to start. If the set is in standby, then it will turn on at the reminder time.

Note: When recording in standby mode, the set will not turn on. While recording in standby, the light on the front of the set will flash.

Channel List

To view the channel list, please ensure that the TV is set to either the analogue or digital source and no menus or TV notifications are displayed.

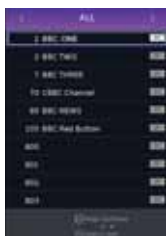

1) Press [OK] on the remote control and the channel list menu will appear.

2) Press [LEFT] or [RIGHT] arrow to filter desired channel types (Digital TV, HD channels, Radio, Data, All).

3) Scroll through the channel list by using ▲▼ buttons then press [OK] to view the channel that is currently highlighted.

4) Press [EXIT] to exit the channel list.

PICTURE MENU



To access this menu, press [MENU] button on the remote control.
To select a sub menu press [OK]

If you wish to make changes to any of the default settings, use the scroll ▲▼▶◀ buttons.
To confirm any settings press [OK] button. To exit this menu at anytime, press [EXIT] button.

Picture Mode - Choose from the following presets:

Dynamic	Recommended settings for fast moving pictures
Standard	Standard settings
Movie	Picture has less colour and is darker.
Personal	Allows you to change the picture settings to your personal preference. These settings are saved automatically.
Economy	Power saving mode which reduces the energy used by up to 25% (by reducing the power to the LED/LCD panel). In Economy mode, the TV will switch itself to Standby mode after 3-5 hours in the event that the TV buttons or remote control buttons are not pressed (change the picture mode to another setting to de-activate this function)

You can make the following adjustments in **Personal** mode:

Contrast - Switch the balance between black and white.

Brightness - Increase or decrease the brightness of the picture.

Colour - Changes the picture between colour and black and white.

Tint - Lets you increase or decrease the level of tint within the picture (only available for NTSC source signal).

Sharpness - Increase or decrease the sharpness of the picture.

Colour Temperature - Choose from the following presets:

Normal	Default settings
Warm	Increases red within the picture
Cold	Increases blue within the picture

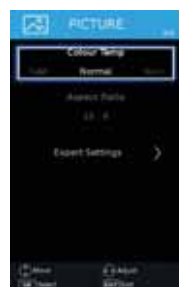

PICTURE MENU

Aspect Ratio - Within the UK the picture format varies depending on the channel/broadcast. There are a number of different options to best meet your needs

Auto

Automatically displays the best picture format so the picture is in the correct position. Black lines may appear at the top/bottom and/or sides.

Full Screen

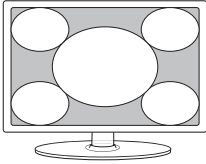

Displays a picture in the full screen mode without overscan. 16:9 signal will be displayed in original proportion. Other picture format will be stretched to fill the screen

4:3

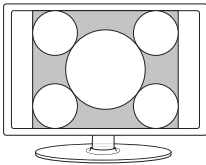

Displays the 4:3 picture in its original size. Side bars are shown to fill the 16:9 screen

Dot by Dot

Will display the picture in its original resolution without any change, only available in HDMI input source

16:9

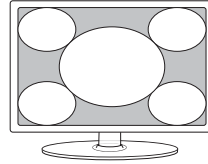

Fills the screen with a regular 16:9 signal and 4:3 picture format will be stretched to fill the screen

Zoom1 and Zoom2

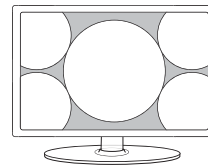

The picture is the correct proportion but zoomed in to fill the screen

Expert settings - Choose from the following options:

Noise Reduction - Switches picture noise reduction 'ON' or 'OFF'.

Active Contrast - Switches optimization of the backlight and contrast of the picture 'ON' or 'OFF'.

SOUND MENU



To access this menu, press [MENU] button on the remote control and scroll right.
To select a sub menu press [OK]

If you wish to make changes to any of the default settings, use the scroll ▲▼▶◀ buttons.
To confirm any settings press [OK] button. To exit this menu at anytime, press [EXIT] button.

Sound Mode - Choose from the following presets:

Standard	Default settings
Music	Emphasises music over voices
Movie	Provides live and full sound for movies
Sports	Emphasises sound for sports
Personal	Allows you to change the sound settings to your personal preference. These settings are saved automatically.

Treble - To adjust the amount of high frequency within the sound.

Bass - To adjust the amount of low frequency within the sound.

Balance - To switch the sound between the left and right speakers.

Auto Volume Level (AVL) - When 'ON' is selected, the volume will attempt to stay at a constant level regardless of TV programme and advertisements.

DTS TruSurround - Choose from the following options:

Off	Disables the DTS TruSurround audio feature
On	TruSurround™ creates an immersive, feature-rich surround sound experience from two speakers, complete with rich bass, high frequency detail and clear dialog.



For DTS patents, see <http://patents.dts.com>. Manufactured under license from DTS Licensing Limited. DTS, the Symbol, & DTS and the Symbol together are registered trademarks. DTS TruSurround is a trademark of DTS, Inc. © DTS, Inc. All Rights Reserved.

SOUND MENU

Digital Output - This is the digital audio output. Choose from the following options:

Off	To turn off Digital Output
Auto	Selects the best settings automatically
PCM	Select this option if you are connecting to a Stereo Hi-fi via a digital audio cable (Pulse-code modulation (PCM) is a digital representation of an analogue signal)

Audio Description - Allows you to switch 'ON' or 'OFF' Audio Description. This provides a description of what is happening during the selected programme for a person who is visually impaired. This feature is not available on all programmes.

AD Volume - This allows you to increase and decrease the AD (Audio Description) volume level.

Audio Track - Allows you to choose between the audio channels being transmitted on Digital Television. Currently for Freeview only normal sound or the Audio Description audio channels can be selected.

Audio Delay - Enables you to adjust setting to sync picture and audio.

SPDIF Delay - Enables you to adjust sound setting to sync picture and audio for external speakers connected via digital audio output.

CHANNEL MENU



To access this menu, press [MENU] button on the remote control and scroll right.
To select a sub menu press [OK]

If you wish to make changes to any of the default settings, use the scroll ▲▼▶◀ buttons.
To confirm any settings press [OK] button. To exit this menu at anytime, press [EXIT] button.

Auto Tuning - Allows you to retune the television for all digital channels, digital radio stations and analogue devices.

Analogue Manual Tuning - Allows you to manually tune your analogue signal.

Freeview/Saorview Manual Tuning* - Allows you to manually tune your digital signal.

Channel Edit - Allows you to delete, move, skip and add programs to a favourite channels list. You can add a favourite channel list which can be accessed by pressing the favourite button on your remote control. This will enable you to select your preferred channels quickly and easily. To add a channel to the favourite list go to; **Menu > Settings > Channel > Channel Edit**. Select the channel which you would like to add to the favourite list and press the favourite button on the remote control. A heart symbol will appear next to the channel name. Repeat for another channel or press Exit to leave the menu. If you now press the favourite button on the remote control your favourite channels will be listed, select your desired channel and press the [OK] button to watch.



Important: To receive Freeview/Saorview channels, in particular HD channels, you will need a Digital TV aerial and be in a good Freeview/Saorview coverage area. You can check the coverage for your area at www.freeview.co.uk or www.saorview.ie

Please note that any Freeview HD channels found during tuning will be placed in channel positions above 100. For example, 101 (BBC1 HD) 102 (BBC2 HD) etc.

***Freeview channels are only available in the UK, Saorview channels are only available in the ROI.**

Signal Information - Allows you to view signal frequency, signal quality and signal strength.

CI Information - Pay per view services require a "Smartcard" to be inserted into the TV. If you subscribe to a pay per view service the provider will issue you with a 'CAM' and a "Smartcard". The 'CAM' can then be inserted into the COMMON INTERFACE PORT (CI Card In).

Note: If you do not press any buttons for 30 seconds, the menu will automatically exit. You can change the length of time before the menu exits automatically - see 'OSD Timer' in the Time Menu

CHANNEL MENU

Schedule List - The schedule list allows you to view your reminders and recordings. It can be accessed by going to the 'Channel Menu' then selecting 'Schedule List' or by pressing the [BLUE] button while in the 'Record List'.

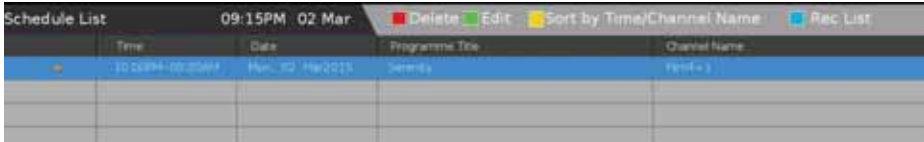

There are two icons, the clock symbol denotes a reminder, the camera indicates a recording. To select use the up and down arrow buttons.

- Press the [RED] button to delete the reminder or recording
- Press the [GREEN] button to edit the reminder or recording
- Press the [YELLOW] button to sort the reminder or recording

Note: Record functions are only applicable to sets with a built in USB Record/PVR function.

Edit Menu - To edit use the up and down buttons on the remote control to select the function, then use the left and right buttons to change. Press the [OK] button to store and return to the schedule list.



Recorded List - Shows a list of recorded TV programmes via a connected USB memory stick or USB hard drive. While in the 'Recorded List', press the [BLUE] button to access the 'Schedule List'. Please see the 'USB RECORD' page for further information.

OAD Scan - Switch 'ON' or 'OFF' OAD updates.

SETTINGS - SETUP MENU

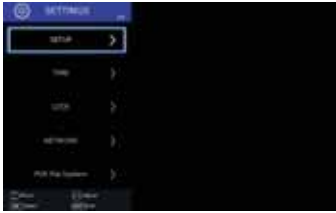

To access this menu, press [MENU] button on the remote control and scroll right.
To select a sub menu press [OK]

If you wish to make changes to any of the default settings, use the scroll ▲▼▶◀ buttons.
To confirm any settings press [OK] button. To exit this menu at anytime, press [EXIT] button.

Set Up - Choose from the following options:

Language - Allows you to change the language of the menu.

Audio Language - Select your preferred primary audio language.

Audio Language 2 - Select your preferred secondary audio language.

Subtitle Language - Select your preferred primary subtitle language.

Subtitle Language 2 - Select your preferred secondary subtitle language.

Hearing Impaired - This allows you to turn on the 'Hearing Impaired' function, this produces subtitles on the screen which provide a description of what is happening during the selected program.

Blue Screen - Changes the background when there is no input between clear and a blue background (Only available on some inputs/sources).

PVR File System - PVR Recording options:

Select disk	Select USB port and disk partition
TimeShift Size	Set size time of shift buffer.
Format Start	You can format connected USB storage device to FAT 32 file system. WARNING: ALL DATA ON THE USB DEVICE WILL BE DELETED
Speed check	Tests write speed of connected USB storage devices.

First Time Installation - Allows you to access the 'First Time Installation' menu and retune the TV set.

Software Update (USB) - Allows you to update your TV with the newest software using a USB memory stick. Software and instructions are available on our website.

Software Update (NET) - Allows you to update your TV with the newest software via your internet connection. This will require the TV to be connected to the internet and have a blank USB memory stick inserted in to the USB input of the TV. The software will be downloaded on to the blank USB memory stick and then complete the update process.

Reset TV - This resets the menus to factory settings and clears all the TV channels from the television.

HDMI CEC (Consumer Electronic Control) - Allows HDMI devices to control each other and allows you to operate multiple devices with one remote control. (only available with compatible devices).

Store Mode - switch 'ON' or 'OFF' shop demonstration mode (available only if store mode was selected during first time installation).

SETTINGS - SETUP MENU

Network menu - Choose from the following options:



The Network connection is only intended to access Pay TV services from your Freeview/Saorview broadcaster. Please note, the TV cannot be used for internet access.

For the network configuration to work the TV will need to be connected to your home network via an ethernet cable, with these requirements in place the TV will connect to the network automatically.

Choose from the following options:

IP Config - Allows you to access LAN network connection settings. choose from the following options:

Auto	Will automatically connect the TV to your home network(this is the default setting and is highly recommended)
Manual	Allows you to manually change the IP, Netmask, Gateway and DNS information.

Network Info - Allows you to view Information about network settings

Network Test - Allows you to test the network connection.

Lock menu - Choose from the following options:



System/Hotel Lock - Allows you to lock or unlock the menu. You will be asked to enter a 4 digit password. Use ◀ button to quit the password input or use the ▶ button to clear. Default password is 0000.

Change Password - Allows you to change the password.

Channel Lock - Allows you to lock certain channels manually.

Parental Guidance - Allows you to set the rating to block certain content based on age information.

Key Lock - Allows you to lock the buttons on the side of the TV set.

Default Source - Allows you to set the default source. The default input source is the source the TV starts on when first switched on.

Default Channel - Allows you to set a channel as the default channel on the Digital source. The default channel is the channel the TV starts on when first switched on.

Max Volume - Allows you to adjust and set the maximum volume.

Source Lock - Allows you to lock the source menu.

Note: To enable controls within the lock menu, the function needs to be enabled by turning on the System Lock.

Note: if you change and forget the password, you will need to use the master reset password of 4711.

SETTINGS - SETUP MENU

Time Menu - Choose from the following options:



Auto Sync - When this option is set to 'ON' the TV will automatically synchronise the time with the Digital Television signal select 'OFF' to access the 'Time' option and manually set the time.

Time - Allows you to manually set the time, only available when Auto Sync is set to 'OFF'.

Off Time - Allows you to set a specific time for your TV to turn off.

On Time - Allows you to set a specific time for your TV to turn on, the channel it will then display, the source it will be on and also the volume. This function can then be toggled to repeat every day or a certain day. If your set is in standby and the on time is reached, it

will turn on.

Sleep Timer - Lets you set the sleep timer so the television automatically switches off after a set amount of time.

(Off -> 10min -> 20min -> 30min -> 60min -> 90min -> 120min -> 180min -> 240min.)

OSD Timer - Lets you adjust the amount of time the On Screen Menu stays on the screen before disappearing.

(Off -> 5secs -> 15secs -> 30secs -> 60secs.)

Auto standby - Set 'Auto Standby' to 'OFF', 3 hours, 4 hours or 5 hours.

Time Zone - Change your current time zone.

LED Status - Allows you to switch the LED power indicator light 'ON' or 'OFF' when the TV is being operated.

(When this option is set to 'OFF' the LED power indicator light will flash when the remote control is used).

Version Info - Allows you to view the version/information of the software installed on the TV set.

Note: For further support with software updates, contact our technical support team or refer to the 'Product Support' section of the website. If the TV is using the newest software available it will not attempt to update the software.

USB MODE/MEDIA PLAYER

USB mode offers playback of various different types of content that you have saved on your USB Memory Stick.

On switching to USB source the below menu screen will appear. The content will be divided into Photo, Music, Movie and ALL based on file type.

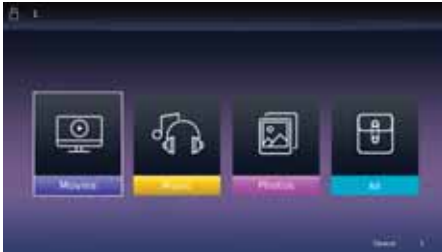

1) You can navigate through the menus using the scroll **▲▼▶◀** buttons. To confirm the item you wish to play/view press [OK] button.



2) Select the drive you require. (If your drive only has 1 partition you will only see 1 item).



3) You can now access the item. Press [OK] to view.



4) Whilst viewing your media, you can control the item by using the remote control playback buttons or by pressing [INFO] you can access the on-screen playback menu, you can now make your selection by using the **▲▼▶◀** and [OK] buttons on the remote control.

Note: If you experience a playback issue, please ensure the files being used are the correct format (example - the picture plays but no sound) See the 'Compatible file types for USB playback' section at the rear of this user guide.

DVD SETUP

(For models with built in DVD players)



To enter this menu please ensure the TV is in DVD source & press [DVD SETUP]

If you wish to make changes to any of the default settings, use the scroll ▲▼▶◀ buttons. To confirm any settings press [OK] button. To exit this menu at anytime, press [DVD SETUP] button.

TV Display - Choose from the following options:

4:3 Pan scan	PS traditional picture format, this is often used with older film formats
4:3 Letter box	LB Traditional picture which has been adapted for widescreen
Wide	16:9 Widescreen picture format

Speaker Setup - Choose from the following options:

LT/RT	Converts from multi-channel sound to mono
Stereo	Converts from multi-channel sound to stereo

Dual Mono - Choose from the following options:

Stereo	Outputs 2 channels of sound both left and right
Mono L	Outputs left side sound
Mono R	Outputs right side sound
Mix Mono	Outputs a single channel of sound but mixed between right and left

Dynamic Range - This is the difference between the quietest and loudest sounds. This setting only works with DVD discs recorded in Dolby digital.

Full	Set this to listen with the range recorded on the disc
3/4	Set this to listen with a range equivalent to a normal television
1/2	Set this to listen with a smaller difference between the maximum and minimum volume
1/4	Set this to listen with a smaller difference between the maximum and minimum volume
Off	Set dynamic range to off

TV Type - Choose from the following options:

PAL	For TVs produced in the UK, Europe, Asia, Australia etc
Multi	For both NTSC and PAL
NTSC	For TVs produced in North America, Japan etc

Default - Choose from the following options:

Reset	Resets all options in the 'DVD setup' menu back to the default settings
-------	---

Note: This TV/DVD player is pre-set to play Region 2 DVDs. In the event you wish to use the TV/DVD in another country that uses different region discs, please visit www.umc-uk.co.uk. Select 'Product Support', 'Changing Region'.

USB RECORD - FREEVIEW/SAORVIEW MODE

The USB Record / PVR function is only available in Freeview/Saorview mode and only when used in conjunction with a compatible USB memory stick or USB hard drive. The benefits of this are as follows:

- Pause live TV and then playback, rewind and fast forward (up to live TV).
- One button record, if you decide you want to record the current programme.
- Easy recording from the 7 Day TV Guide.

Due to the nature of the product, it is necessary to use a high speed USB memory stick (as the TV reads from and writes to the memory stick at the same time, some memory sticks may not be suitable).



You can purchase high speed memory sticks from some computer stores, alternatively, we have a selection of tested and compatible memory sticks available to purchase directly from the Helpline/website.

Recommended Minimum Specification - USB Memory Stick:

Read Speed	20 Mb/s (Megabits Per Second)	If you wish to use a USB portable hard drive larger than 32GB, please refer to the FAQ section at the rear of this user guide.
Write Speed	6 Mb/s (Megabits Per Second)	

Pause Live TV (Time Shift)

A USB memory stick/hard drive must be connected to the TV in order to use this feature.

-  - Press the play/pause button and the television will pause and the live content will be recorded. To resume watching press play/pause again.
-  - Press fast forward to go forward in a recording.
-  - Press fast rewind to go back in a recording.

Note: When you switch the TV to standby or change channel the 'Time Shift' memory is wiped. To restart time shift you must press play/pause button.

Note: If channels are moved or deleted, then the USB Record/PVR will not function correctly.

Note: This television contains one TV tuner, therefore it can only record the channel you are watching or record one channel while the television is in standby mode.

Note: USB Record/PVR record function is only available in Digital/Freeview TV mode. Due to copyright laws and illegal copying/recording it is not possible to record to/from any other input/output source.

Note: Recorded content can only be played back on the device that recorded it. It is not permitted (or possible) to watch content recorded on the TV from Freeview/Saorview on another device.

USB RECORD - FREEVIEW/SAORVIEW MODE

One Button Record

At any point in time you may decide to record the current programme that you are watching. To do this you need to press the red record button on the remote control.

Playback files from Record list

To playback recorded files you will be required to have the TV set to the Freeview/Saorview source mode. Once set to the correct source, access the recorded list by pressing the [REC LIST] (Recorded List) button on the remote control, the recorded list should now appear on the screen. Use the arrow buttons on the remote control to navigate to the recording you wish to playback and then press [OK] on the chosen file to start playback.

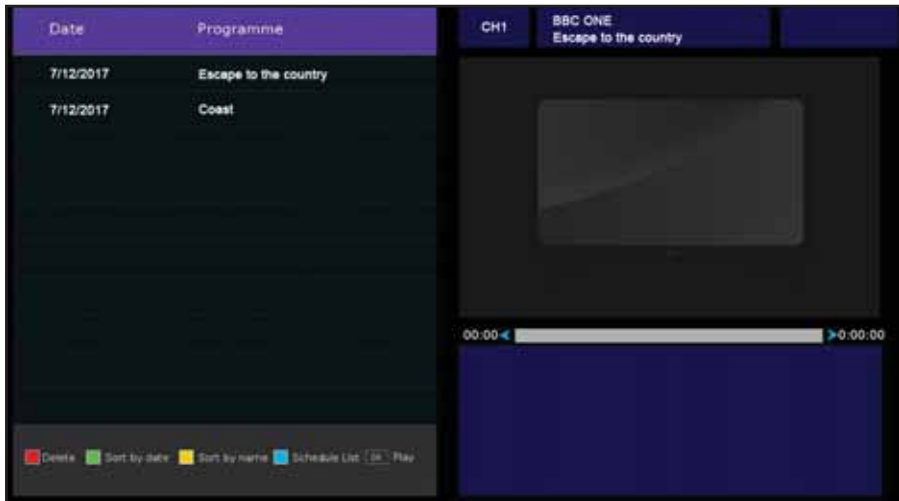

Use the coloured buttons on the remote control for the following options:

- Press [RED] to delete a selected recording.
- Press [GREEN] to sort the items in the record list by date.
- Press [YELLOW] to sort the items in the record list by name.
- Press [BLUE] to enter the schedule list.

Note: Record functions are only applicable to sets with the built in USB Record/PVR function.

FREQUENTLY ASKED QUESTIONS

General	I would like to have louder sound by connecting additional speakers or a Soundbar..	<p>1) Use either the 3.5mm headphone output on the TV and a 3.5mm to phono cable (available separately) to connect to an amplifier/surround sound/soundbar. Please note this will deactivate the TV's built in speakers.</p> <p>or:</p> <p>2) Connect a digital optical audio cable from the TV's digital optical audio output to your amplifier/surround sound/soundbar digital optical audio input..</p>
General	Why are some options in the menu unavailable and greyed out.	Some options are only available in certain inputs/sources, i.e. HDMI. They are unavailable in the other sources where they have no effect.
General	Can I stop my TV automatically turning off after 4hrs?	Yes, in the 'Time' menu settings, scroll down to Auto standby and select OFF.
TV	I have tuned in Digital TV but I am not receiving any or all of the channels and/or the channels I receive are breaking up.	<p>1) Check you are in an area that can receive Freeview/Saorview, visit www.freeview.co.uk or www.saorview.ie</p> <p>2) Check you are using an aerial that is able to receive a good digital signal. In most cases, you will need an outdoor digital hi-gain/wideband aerial. In areas that have excellent digital coverage, you may be able to use a loft type aerial but it is highly likely that you will also need to connect a booster between the back of the TV and the TV aerial wall socket. Unfortunately, to receive a good enough digital signal, it is not possible to use a portable/indoor type aerial.</p>
TV	I have re-tuned my television but when I switch it off it is not storing the channels.	<p>If the TV does not save the channels when you power it off, it's likely the channel database has become corrupt.</p> <p>1) Turn off the TV.</p> <p>2) Remove the RF/Aerial cable from the rear of the TV and then turn the TV back on again.</p> <p>3) Using the remote control, press Menu followed by 8-8-8-8 to enter the initial setup/first time installation menu.</p> <p>4) Press OK (let the TV run the full tuning process).</p> <p>5) Once completed, turn off the TV, reconnect the RF/Aerial cable then turn the TV back on again.</p> <p>6) Repeat steps 3 & 4.</p>
VCR/DVD Recorder	I have connected the TV to my VCR or DVD Recorder via SCART but it is not recording.	In addition to connecting via SCART, you should connect the aerial cable from the wall socket to your VCR/DVD Recorder and another aerial cable from the VCR/DVD Recorder to the TV.
Game Consoles	I have connected my Playstation/Xbox to the TV via HDMI, but I am not receiving any pictures or sound on my Television.	<p>1) Ensure the TV's source is set to HDMI.</p> <p>2) Check your settings on your Playstation/Xbox are as per the Playstation/Xbox instruction manual.</p>
Game Consoles	I have connected my Playstation/Xbox to the TV via Component cables (red, green & blue) but I am not receiving any sound.	Component cables only provide HD pictures. For the sound you will need to connect the red & white audio cables on the Playstation/Xbox to the red & white phono inputs (or mini AV input where fitted) on the rear of the TV. Please refer to the 'Connections' pages.
System Lock	I have changed the password on the television and now forgotten it.	There is a master password of 4711, to gain access to the TV menu and reset the normal password.
USB Mode	I have inserted a USB Memory Key, but the TV does not recognise it.	Ensure the USB Memory Key is formatted to type FAT32.
USB Mode	Using a USB portable hard drive / larger than 32GB.	If you wish to use a portable hard drive larger than 32GB, please note that it must be formatted to the FAT32 file system in order to operate on this TV. Windows XP/Vista computers are only capable of formatting up to 32GB, therefore, you will need a software programme/utility to format larger hard drives. Please refer to the website, www.umc-uk.co.uk , for more information.

FREQUENTLY ASKED QUESTIONS

DVD (For TV models with DVD only)	I have inserted a disc but it is not playing.	<p>1) Ensure you have inserted the disc facing the correct way.</p> <p>2) Ensure the disc is clean and is not scratched.</p> <p>3) Some copied discs will not play.</p> <p>4) Check the DVD is a region 2 disc – to change the region of the DVD player, refer to www.umc-uk.co.uk, select 'Changing DVD Region' in the 'Product Support' section</p>
DVD (For TV models with DVD only)	I have pressed the eject button but the disc is not coming out.	To eject the disc hold the stop/eject button for 4 seconds.
USB Record (For TV models with USB record only)	I cannot change the channel, access the menu or use the red button.	During time shift you cannot change the channel, access the menu or use the red button.
USB Record (For TV models with USB record only)	When using the USB to record the picture 'breaks up' or experience loss of sound.	Check the USB memory stick meets the minimum read speed requirements. Standard definition channels require a read speed of 20 Mb/s (Megabits per second) and a write Speed of 6 Mb/s (Megabits per second) HD channels require the read speed of 80 Mb/s (Megabits per second) and a write speed of 40 Mb/s (Megabits per second). USB 3.0 sticks should be used where possible.
Freeview HD	I cannot access all Freeview channels.	Some data channels for Freeview can only be obtained when the TV's ethernet port is connected to your router.
Freeview HD	I cannot find the Freeview HD channels.	Freeview HD channels found during tuning will be placed in channel positions above 100. For example, 101 (BBC1 HD), 102 (BBC2 HD) etc.

COMPATIBLE FILE TYPES FOR USB PLAYBACK

Media	File Ext.	Codec		Remark
		Video	Audio	
MOVIE	.mpg	MPEG-1, MPEG-2		Max Resolution: 1920x1080
				Max Data Rate: 40 Mbps
	.avi	Xvid, MJPEG		MP3, AAC, AC3, PCM, Max Resolution: 1920x1080 Max Data Rate: 20 Mbps
		MPEG-4 SP/ASP, H.263/H.264		
	.ts	MPEG-2, H.264, HEVC		
	.mov	MPEG-4 SP/ASP, H.263/H.264, HEVC		
	.mkv	MPEG-4 SP/ASP, H.263/H.264, HEVC		
	.dat	MPEG-1		
.mp4	MPEG-4 SP/ASP, H.263/H.264, HEVC			
	MPEG-1, MPEG-2			
.vob	MPEG-2		Max Resolution: 720x576 Max Data Rate: 40 Mbps	
MUSIC	.mp3	--	MP3	Sample Rate: 8K~48KHz Bit Rate: 32K~320Kbps
	.m4a/.aac	--	AAC	Sample Rate: 16K~48KHz Bit Rate: 32K~442Kbps Channel: Mono/Stereo
PHOTO	.jpg/	Progressive JPEG		Max Resolution: 1024x768
	.jpeg	Baseline JPEG		Max Resolution: 15360x8640
	.bmp	BMP		Max Resolution: 9600x6400
				Pixel Depth: 1/4/8/16/24/32 bpp
	.png	Non-Interlaced		Max Resolution: 9600x6400
Interlaced		Max Resolution: 1280x800		
SUBTITLE	.srt	SubRip		
	.ssa/.ass	SubStation Alpha		
	.smi	SAMI		
	.sub	SubViewer MicroDVD		SubViewer 1.0 & 2.0 Only
		DVDSubtitleSystem SubIdx(VobSub)		
.txt	TMPlayer			









SHA/MAN/0331



UMC Poland sp. z o.o

Ostaszewo 57B, 87-148 Lysomice,
Poland

Assembled in Poland

www.sharp.eu/av

SHARP