

# SHARP

LED TV with Freeview HD, Saorview & USB PVR

User Guide

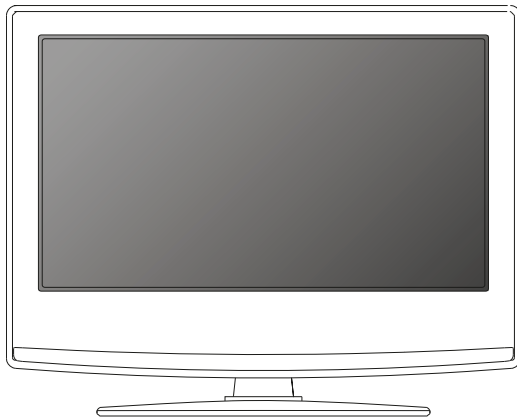

Model No

LC-32CHG4041K

LC-32DHG4041K

LC-40CFG4041K

## Important safety instruction



**Please read these instructions. All the safety and operating instructions should be read before the appliance is operated.**

### Warnings

- Television sets with 40" screen size or more must be lifted and carried by at least 2 people.
- This television does not contain any parts that are serviceable by the user. In case of a fault, contact the manufacturer or authorised service department. Exposing the internal parts inside the TV may endanger your life. The manufacturers guarantee does not extend to faults caused by repairs carried out by unauthorised third parties.



To prevent spread of fire, keep candles or other open flames away from this product at all times

- To reduce the risk of fire, electric shock or damage to the TV, do not expose it to dust, rain or moisture. Never expose the TV to dripping or splashing and do not place objects filled with liquids on or near the TV.
- Do not connect any external devices (DVD player, games console etc) when the TV is switched on. Disconnect both the TV and device from the mains before connecting. Only switch appliances on when the connection process is complete.
- Do not place the television in a confined space and do not obstruct the ventilation openings at the rear of the television.
- When installing on a wall, ensure the TV is at least 5cm from the wall for ventilation.
- Always ensure that the TV's ventilation openings are not covered with items such as newspapers, table-cloths, curtains, etc.
- Dispose of this television and any components including batteries in an environmentally friendly manner. If in doubt, please contact your local authority for details of recycling.
- Ensure this TV is used in moderate climates only.
- In case of electrostatic discharge (ESD) the TV may display incorrect functions. In such case, switch the TV off and switch the TV back on. The TV will work normally.

**WARNING: Never place a television set on an unstable location. A television set may fall, causing serious personal injury or death. Many injuries, particularly to children, can be avoided by taking simple precautions such as:**

- Use cabinets or stands recommended by the manufacturer of the television set.
- Only use furniture that can safely support the television set.
- Ensure the television set is not overhanging the edge of the supporting furniture.
- Do not place the television set on tall furniture (for example, cupboards or bookcases) without anchoring both the furniture and the television set to a suitable support.
- Do not place the television set on cloth or other materials that may be located between the television set and supporting furniture.
- Please educate children about the dangers of climbing on furniture to reach the television set or its controls.
- If your existing television set is being retained and relocated, the same considerations as above should be applied.

### Safety

- For your safety, this appliance is fitted with a fused 3 pin mains plug. Should the fuse need to be replaced, ensure that any replacement is of the same amperage and approved with the BSI mark.
- Never try and replace the mains plug unless you have adequate qualifications and are legally authorised to do so. In the event that a replacement mains cable is required, contact the manufacturer for a suitable replacement.
- Never use the television if it is damaged in any way.
- Always place the television on a flat level surface avoiding anywhere which may be subject to strong vibration.
- The ideal distance to watch the television is approximately five times the length of the diagonal measurements of the TV screen.
- Ensure the television is not placed on top of the power cable as the weight of the television may damage the cable and cause a safety hazard.
- Never place mobile phones, speakers or any other device which may cause magnetic or radio interference, near the television. If interference is apparent, move the device causing the interference away from the television.
- To disconnect the apparatus from the mains, please use the mains plug located on the underside/rear of the TV.
- Ensure that the mains plug is always easily accessible.

**WARNING: Excessive noise when using earphones and headphones can cause loss of hearing.**

## Important safety instruction



- Time displays.
- Teletext: Do not view a stationary page for a long period of time
- TV/DVD menus: e.g. listings of DVD disc content.
- Pause mode: Do not leave the TV in pause mode for long periods of time, e.g. when watching DVDs or videos.

**Important: Once 'shadow image/screen burn' occurs, it will never disappear and is not repairable under warranty.**

## Maintenance

- To clean your TV, wipe with a soft, dry cloth. If the surfaces are extremely dirty, use a soft cloth dipped in a soap and water solution or a weak detergent solution.
- Never use alcohol, paint thinner or benzene to clean this unit.
- Before using a chemically treated cloth, read the instructions that came with the cloth carefully.

**CAUTION: If water or other liquid enters the television through the display panel surface, a malfunction may occur.**



## Packaging

- The safest way to transport your item is in the original box/packaging - please save your packaging for this.
- You will need the original box/packaging in the event of warranty/service repair or support. We are unable to carry out warranty/service if you are unable to package the item correctly.

## Important information regarding use of video games, computers, captions or other fixed image displays

The extended use of fixed image program material can cause a permanent "shadow image" on the LCD/LED panel, also known as "screen burn".

This "shadow image" can appear in the background during normal viewing. This type of irreversible LCD/LED panel deterioration can be limited by observing the following steps:

1. Reduce the brightness/contrast setting to a minimum suitable viewing level.
2. Do not display the fixed image for extended periods of time.
3. Turn the power off when not in use.

Examples of images that are more likely to cause "screen burn" are as follows (this is not an exhaustive list):

- TV channel logos: e.g. shopping channel logos and pricing displays - especially if they are bright and stationary. Moving or low-contrast graphics are less likely to cause ageing of the screen.

## How do I dispose of this product?

**UK:** Waste electrical products should not be disposed of with household waste. Please dispose of the product at a designated collection point for recycling of WEEE. For your nearest facilities, please see [www.recycle-more.co.uk](http://www.recycle-more.co.uk) or in store for details.



**ROI:** Waste electrical products should not be disposed of with household waste. Separate disposal facilities exist. Check with your local authority or retailer for recycling advice.



## Batteries

- Do not expose batteries to high temperatures, excessive heat, prolonged sunshine or fire as this may cause leakage, explosion or ignition. Observe the correct polarity when inserting batteries.
- Do not use different types of batteries together or mix old and new batteries.
- Dispose of batteries in an environmentally friendly way.
- Certain regions may regulate the disposal of batteries. Please consult your local authority.

## Trademarks



The terms HDMI and HDMI High-Definition Multimedia Interface, and the HDMI Logo are trademarks or registered trademarks of HDMI Licensing, LLC in the United States and other countries.

### HDTV

The "HD TV" Logo is a trademark of DIGITALEUROPE.

### HDTV 1080p

The "HD TV 1080p" Logo is a trademark of DIGITALEUROPE.

### HD READY

The "HD Ready" Logo is a trademark of DIGITALEUROPE.

### HD READY 1080p

The "HD Ready 1080p" Logo is a trademark of DIGITALEUROPE.

### DVB

The DVB logo is the registered trademark of the Digital Video Broadcasting (DVB) project.

### FREEVIEW

The FREEVIEW words and logos are trade marks of DTV Services LTD. © DTV Services Ltd.

### SAORVIEW

SAORVIEW is a registered trademark owned by RTÉ.



Manufactured under license from Dolby Laboratories. Dolby, Dolby Audio and the double-D symbol are trademarks of Dolby Laboratories.



The "CI plus" Logo is a trademark of CI Plus LLP.

### Harman / Kardon

Harman Kardon is trademark of HARMAN International Industries, Incorporated, registered in the United States and/or other countries.



For DTS patents, see <http://patents.dts.com>. Manufactured under license from DTS Licensing Limited. DTS, the Symbol, & DTS and the Symbol together are registered trademarks. DTS TruSurround is a trademark of DTS, Inc. © DTS, Inc. All Rights Reserved.

## TV Models with built in DVD players

### CAUTION:



This caution label is located on the rear panel of the unit

THIS UNIT IS A CLASS 1 LASER PRODUCT. THIS UNIT USES A VISIBLE LASER BEAM WHICH COULD CAUSE HAZARDOUS RADIATION EXPOSURE IF DIRECTED. BE SURE TO OPERATE THE PLAYER CORRECTLY AS INSTRUCTED. WHEN THIS UNIT IS PLUGGED INTO THE WALL OUTLET, DO NOT PLACE YOUR EYES CLOSE TO THE OPENINGS TO LOOK INTO THE INSIDE OF THIS UNIT. USE OF CONTROLS OR ADJUSTMENTS OR PERFORMANCE OF PROCEDURES OTHER THAN THOSE SPECIFIED HEREIN MAY RESULT IN HAZARDOUS RADIATION EXPOSURE. DO NOT OPEN COVERS AND DO NOT REPAIR YOURSELF. REFER SERVICING TO QUALIFIED PERSONNEL.

---

# CONTENTS

---

Manufacturers guarantee information . . . . .	3
Important safety instructions . . . . .	4-5
Trademarks . . . . .	6
What is included in the box . . . . .	8
Attaching / detaching the stand . . . . .	9
Securing the TV to a wall / wall mounting . . . . .	10
Remote control . . . . .	11
TV Control Stick and Input Source menu . . . . .	13
Connections . . . . .	14-16
TV menu operation . . . . .	17-24
Picture menu . . . . .	17-18
Sound menu . . . . .	19-20
Channel menu . . . . .	21
Settings menu . . . . .	22-25
Lock menu . . . . .	23
Time menu . . . . .	24
Network menu . . . . .	24
7 day TV guide and channel list . . . . .	26
DVD setup . . . . .	27
USB record - Freeview / Saorview . . . . .	28
USB mode / media player . . . . .	29
General information . . . . .	30-35
Frequently asked questions . . . . .	30-31
Technical specifications . . . . .	32-35

# WHAT IS INCLUDED IN THE BOX

## Accessories

Included with this TV are the following accessories.

1 x User guide



1 x Remote Control



1 x Quick start guide



2 x AAA Batteries



1 x TV



1 x Mini component / YPbPr cable  
(for 32" models only)



1 x Mini composite / AV cable  
(for 32" models only)



1 x RF cable



1 x Stand installation pack

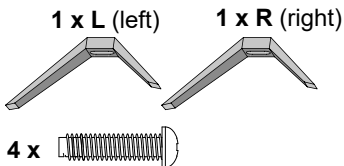

Please save your box/packaging as you will need this in the event of warranty/service repair or support. We are unable to carry out warranty/service if you are unable to package it correctly. The safest way to package your item in the event of warranty/service repair is in its original box/packaging.

# ATTACHING THE STAND

## Attaching the stand

To complete the stand feet installation you will require a cross head screw driver.

Screws that are included.

4 x 

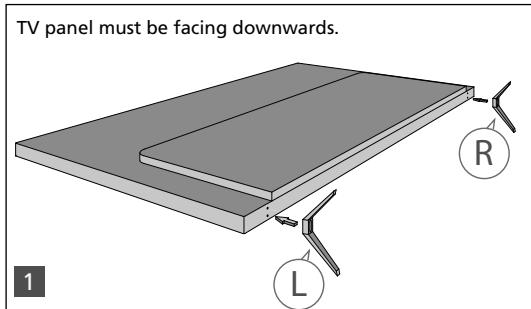

(fig.1) Place the TV set on a flat and clean surface with the panel facing downwards to avoid damage, then fix the stand feet shown. **The feet are marked L (left) and R (right).**

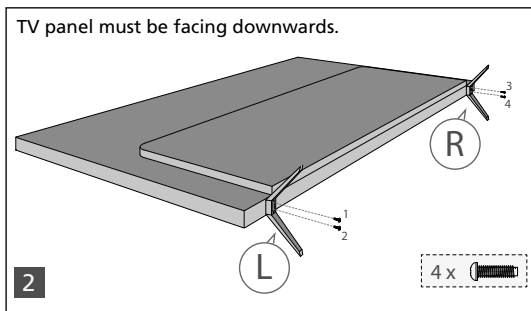

(fig.2) Secure the stand feet to the underside of the TV set using the screws provided.

## Detaching the stand

Remove the screws highlighted then remove the stand feet from the underside of the TV set.

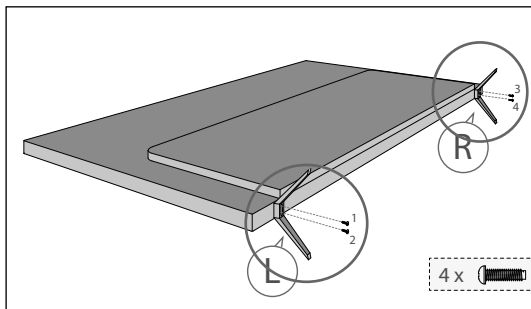

# SECURING THE TV TO A WALL

## Securing the TV to a wall with anti-tip straps

For maximum security in the home when using a TV with its stand anti-tip straps should be fitted. These are available from supermarket websites and other websites and are an easy, inexpensive and effective way of ensuring your TV stays safely upright. Straps are designed to be attached to the rear of the TV and then tethered to the wall or the furniture the TV is stood on.

**Note - Please ensure that children do not climb on the TV set.**

**A)** Using one or both of the top wall-mounting holes and screws (the screws are already supplied in the wall mounting holes) fasten one end of the fastening cord/s to the TV.

**B)** Secure the other end of the fastening cord/s to your wall. (you will need screws/fixings suitable for your wall type - available separately from most DIY stores).

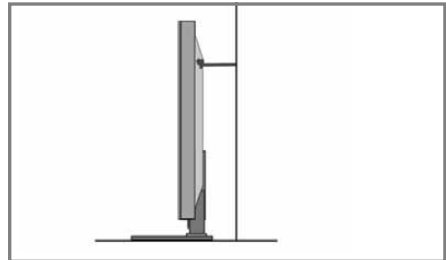
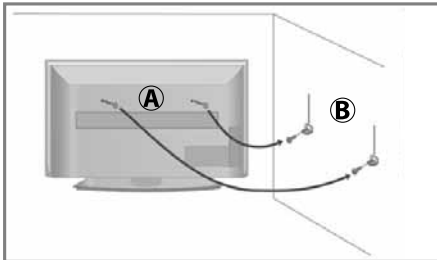

The Royal Society for the Prevention of Accidents is urging people to take care with flat-screen televisions. RoSPA stated in 2010 that "Toddlers are particularly at risk of pulling flat-screen televisions on to themselves. They are unsteady on their feet and are attracted by colourful television images." The risk is increased as televisions become lighter.

## Wall Mounting

**IMPORTANT - Before drilling any holes in the wall ensure you are not drilling where there could be any electrical wires, water or gas pipes.**

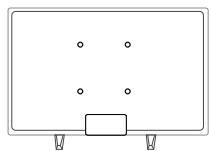

- 1) Remove the four screws highlighted that are supplied in the wall mounting holes.
- 2) The wall mount can now be easily attached to the mounting holes on the rear of the TV.

For VESA wall mounting information please refer to the Technical Specification page.

For optimum viewing, if wall mounting the TV higher than eye level, the TV should be tilted downwards so that the TV's screen is 'face on'. See fig 1 and 2.

fig 1 INCORRECT

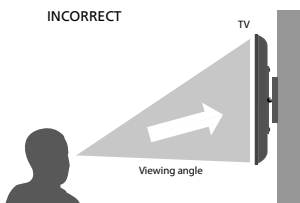
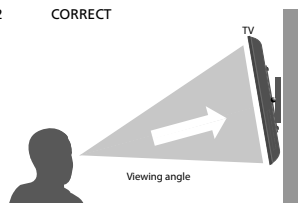

fig 2 CORRECT







**Important – If wall mounting this TV, only use the screws already provided in the wall mounting holes. Using other screws which are longer could cause irreparable damage to internal parts.**



# REMOTE CONTROL

## Key

-  For models with integrated DVD players.
-  For models with PVR Function.
-  For models with USB Playback.
-  For models with 3D functions.



1

- STANDBY** - Switch on the TV when in standby or vice versa.
- SOURCE** - To display the input/source menu.
- MUTE** - Mute the sound or vice versa.

2

- NUMBER BUTTONS** - 0-9 to select a TV channel directly.
- TV GUIDE** - Opens the 7 day TV guide (digital TV mode).
-  - To return to the previous channel viewed.
- MEDIA** - Access the
- RADIO** - Access the radio channels
- SLEEP** - Sets the TV to sleep mode
- ASPECT** - Adjust the TV aspect ratio







3







- VOL (+/-)** - To increase/decrease the sound level.
- TV** - Switches to the Digital TV source.
- INFO** - Press once for now/next channel information.  
- Press twice for information about the current programme.
- CH (+/-)** - To increase or decrease the channel being watched.
- SUBTITLE**  - To switch the dialogue at the bottom of the screen (on/off).
- TEXT**  - To enter/exit Text.

4

- MENU** - To display OSD menu.
- FAV** - To display favourites menu.
- EXIT** - To exit all menus.
- (▲/▼/◀/▶/OK)** - Allows you to navigate the on-screen menus and adjust the system settings to your preference. When there is no menu displayed on the screen, you will be able to adjust the picture/sound settings on the TV, use the ▲ button to change the picture settings and the ▼ button to change the sound settings.

5

-  - To play in fast rewind mode
-  - To play in fast forward mode
-  - To play/pause
-  - To restart the current chapter
-  - To advance forward to the next chapter
-  - To stop the playback/Eject Disc  
(To EJECT the disc press/hold the  button for 4 seconds)

-  **RECORD/DVD MENU** - Access the USB record function/Access the DVD menu of the DVD inserted (must be set to the DVD source).
-  **REC LIST/DVD SETUP** - Opens the list of previously recorded items/Access the TV's DVD setup menu (must be set to the DVD source).
-  **A-B** - Press once to set point, press a second time to return to point.
-  **ANGLE** - Select an alternative camera angle during playback of the DVD.
-  **REPEAT** - To repeat playback.
-  **GOTO** - To go to a specific chapter.



Buttons to use when pairing the remote control to the TV.

If the remote control does not function with the TV, the remote control may need to be paired with the TV set, please refer to the 'Frequently Asked Questions' pages for more information.

# TV CONTROL STICK AND INPUT SOURCE MENU



An example of the 'Input Source' menu (will vary by model)

## TV Control Stick

TV control stick is located on the back of the TV in the left bottom corner. The control stick can be used to control many of the TV functions.

### While TV is in standby mode:

- Press the centre of the control stick once - Power on the TV set

### While watching TV:

- RIGHT/LEFT – volume up/volume down
- UP/DOWN – changes channel up/down
- Press the centre of the control stick once – Displays Menu
- Press and hold the centre of the control stick – Standby Power Off

### While in menu:

- RIGHT/LEFT/UP/DOWN – navigation of cursor in on-screen menus
- Press the centre of the control stick once – OK/Confirm selected item
- Press and hold the centre of the control stick – Back to previous menu

**Note:** The shape of the TV control stick may vary by model.

## Choosing Mode Input/Source

Use the source menu to switch between input/connections.

### A) Using the buttons on the remote control:

1. Press [SOURCE] - The source menu will appear.
2. Press [<] or [>] to select the input you require.
3. Press [OK].

### B) Using the TV control stick:

1. Press the centre of the control stick once to enter the TV menu.
2. Press the control stick left/right and navigate through to SOURCE menu.
3. Press the centre of the control stick to enter the SOURCE menu.
4. Press the control stick up/down to scroll through and select the input/source you require.
5. Press the centre of the control stick to select the chosen input/source option highlighted.

For further information on input/connections please view 'Connections' pages.

# CONNECTIONS

Input/Outputs for the 32" models only.

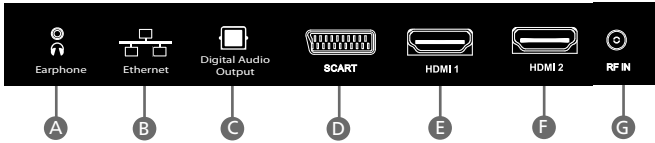
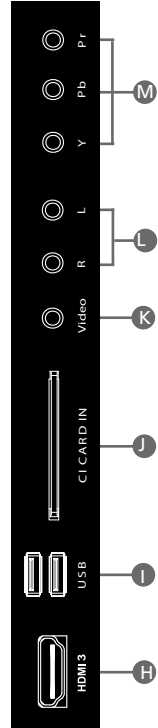
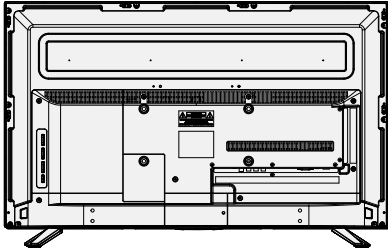

<b>A</b>	<b>EARPHONE</b>	Earphone socket
<b>B</b>	<b>LAN*</b>	Network connection
<b>C</b>	<b>Digital audio</b>	Digital optical audio output
<b>D</b>	<b>SCART</b>	SCART input
<b>E</b>	<b>HDMI 1 (ARC)</b>	HDMI input
<b>F</b>	<b>HDMI 2</b>	HDMI input
<b>G</b>	<b>RF IN</b>	RF/TV Aerial Input

<b>H</b>	<b>HDMI 3</b>	HDMI input
<b>I</b>	<b>USB x 2</b>	USB port
<b>J</b>	<b>CI card in</b>	Common interface module
<b>K</b>	<b>Video</b>	Composite Video/CVBS input
<b>L</b>	<b>L/R</b>	L/R Audio shared for Composite Video/CVBS and component/YPbPr
<b>M</b>	<b>YPbPr</b>	HD input (Ypbpr)

\*The LAN/Ethernet port is used for Freeview HD services.

# CONNECTIONS

Input/Outputs for the **40"** models only.

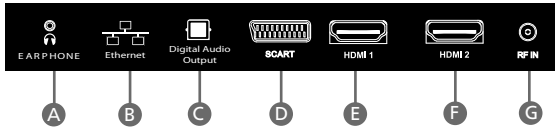
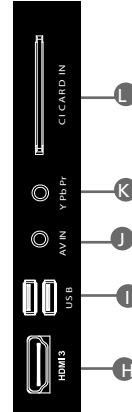
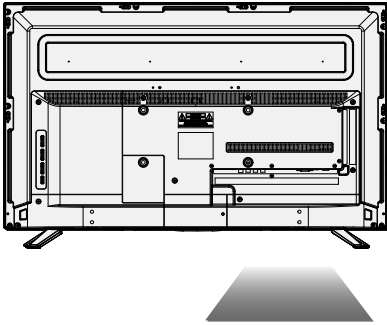

<b>A</b>	Earphones	Earphone input
<b>B</b>	LAN*	Network connection
<b>C</b>	Digital audio	Digital optical audio output
<b>D</b>	SCART	SCART input
<b>E</b>	HDMI 1	HDMI input (ARC)
<b>F</b>	HDMI 2	HDMI input
<b>G</b>	RF in	RF / TV aerial input

<b>H</b>	HDMI 3	HDMI input (MHL Port)
<b>I</b>	USB x 2	USB port
<b>J</b>	AV in	Audio/video input
<b>K</b>	YpBPr	HD input (Ypbpr)
<b>L</b>	CI card in	Common interface module

\* The LAN/Ethernet port is used for Freeview HD services.

# CONNECTIONS

Note: Connecting cables are shown for example only and may not be included. Please check 'What Is Included In The Box' page.

## Connecting to a device with Composite AV/Video output

TV Source should be set to Composite/AV. For 32" models only.

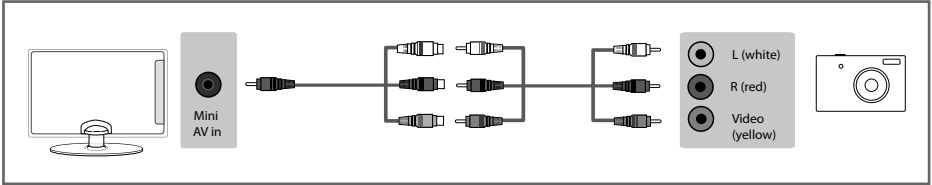

## Connecting to a device with Composite AV/Video output

TV source should be set to Composite/AV. For 40" models only.

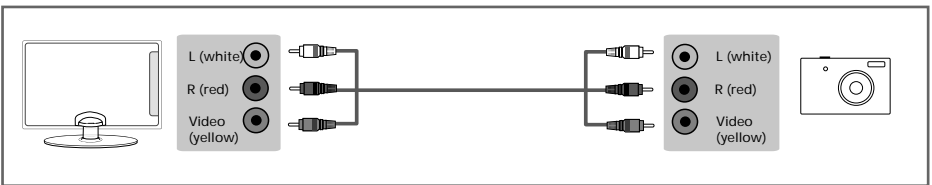

## Connecting to a device with SCART output

TV source should be set to SCART



## Connecting to a device with HDMI output

A HDMI cable can output both video and audio and enables you to enjoy digital-quality video and audio with minimal loss of quality.

TV source should be set to the corresponding HDMI port (HDMI 1, HDMI 2 etc)

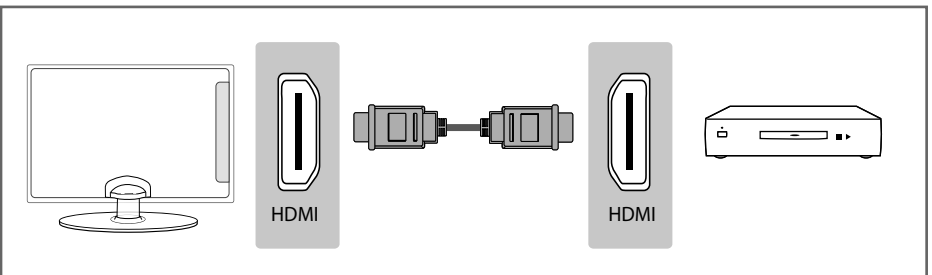

# CONNECTIONS

## Connecting to a device with Component/YPbPr output

If you are supplied with a cable from the device which has red, green, blue, red & white connectors you must connect via Component (for picture) and by phono cable (for sound).

TV source should be set to Component/YPbPr. For 32" models only.

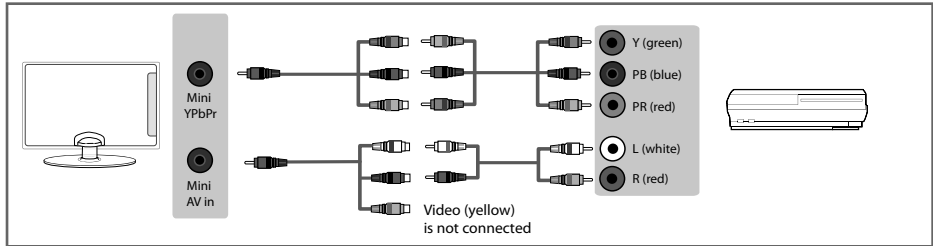

TV source should be set to Component/YPbPr. For 40" models only.



## Connecting to an external audio device (Amplifiers, Surround Sound, Sound Bars etc)

When connecting via the TV's 3.5mm earphone output, this will disable the TV speakers.

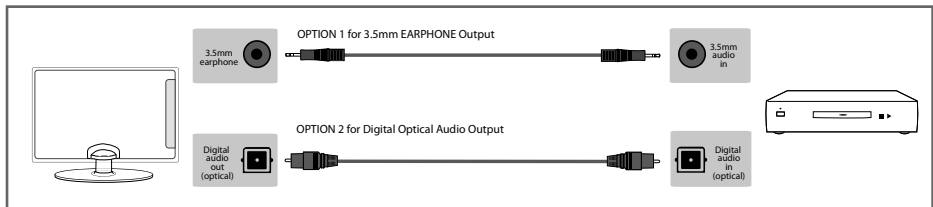

## Connecting an Ethernet/Network cable

The LAN/Ethernet port is used for Freeview HD services.

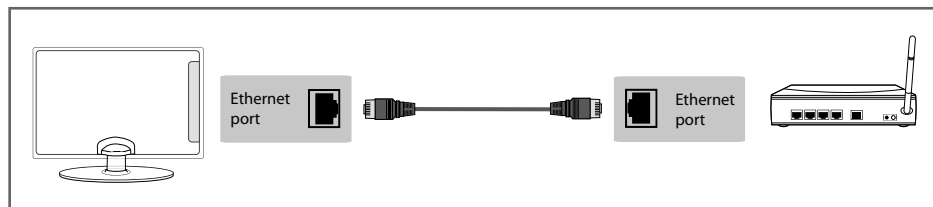

# PICTURE MENU

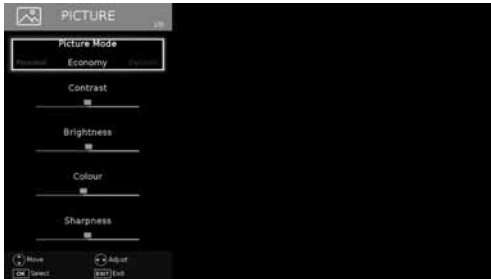

To access this menu, press [MENU] button on the remote control.  
To select a sub menu press [OK]

If you wish to make changes to any of the default settings, use the scroll ▲▼▶◀ buttons.  
To confirm any settings press [OK] button. To exit this menu at anytime, press [EXIT] button.

Picture Mode - Choose from the following presets:

Dynamic	Recommended settings for fast moving pictures
Standard	Standard settings
Mild	Set to be lighter in colour and less bright
Personal	Lets you manually alter all the settings
Economy	Power saving mode which reduces the energy used by up to 25% (by reducing the power to the LED/LCD panel). In Economy mode, the TV will switch itself to Standby mode after 3-5 hours in the event that the TV buttons or remote control buttons are not pressed (change the picture mode to another setting to de-activate this function)

You can make the following adjustments in **Personal** mode:

- Contrast - Switch the balance between black and white.
- Brightness - Increase or decrease the brightness of the picture.
- Colour - Increases the colour from black and white.
- Tint - Lets you increase or decrease the level of tint within the picture (only available for NTSC input signal).
- Sharpness - Increase or decrease the sharpness of the picture.

Colour Temperature Choose from the following presets:

Normal	Default settings
Warm	Increases red within the picture
Cold	Increases blue within the picture

# PICTURE MENU

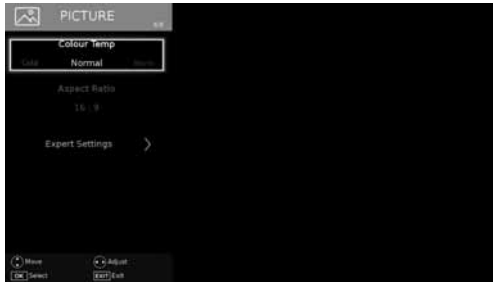

To access this menu, press [MENU] button on the remote control.  
To select a sub menu press [OK]

If you wish to make changes to any of the default settings, use the scroll ▲▼▶◀ buttons.  
To confirm any settings press [OK] button. To exit this menu at anytime, press [EXIT] button.

Aspect Ratio - Within the UK the picture format varies depending on the channel/broadcast. There are a number of different options to best meet your needs. Choose from the following settings:

## Auto

Automatically displays the best picture format so the picture is in the correct position, black lines maybe viewable at the top/bottom and/or sides.

## 4:3

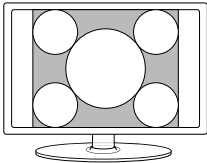

Displays the 4:3 picture in its original size. Side bars are shown to fill the 16:9 screen

## Full Screen

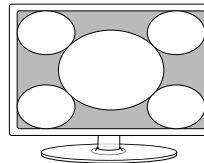

Displays a picture in the full screen mode without overscan. 16:9 signal will be displayed in original proportion. Other picture format will be stretched to fill the screen.

## 16:9

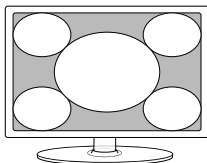

Fills the screen with a regular 16:9 signal and 4:3 picture format will be stretched to fill the screen

## Zoom1 and Zoom 2

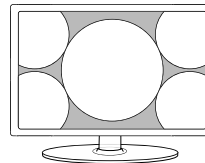

The picture is the correct proportion but zoomed in to fill the screen



# SOUND MENU

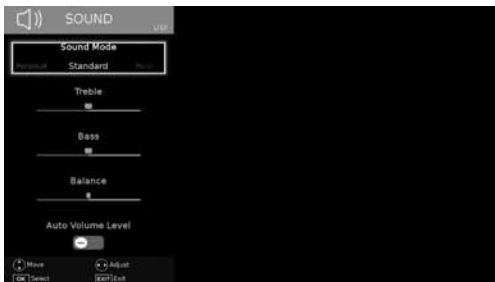

Sound Mode - Choose from the following presets

Standard	Default settings
Music	Emphasises music over voices
Movie	Provides live and full sound for movies
Sports	Emphasises sound for sports
Personal	Selects your personal sound settings

You can make the following adjustments in Personal mode:

- Treble - Allows you to adjust treble levels to suit your listening preferences.
- Bass - Allows you to adjust bass levels to suit your listening preferences.
- Balance - To switch the sound between the left and right speakers.

Auto Volume Level (AVL) - When 'on' is selected, the volume will attempt to stay at a constant level regardless of TV programme and advertisements.

DTS TruSurround - Choose from the following presets

Off	Off
On	On - TruSurround™ creates an immersive, feature-rich surround sound experience from two speakers, complete with rich bass, high frequency detail and clear dialog



For DTS patents, see <http://patents.dts.com>. Manufactured under license from DTS Licensing Limited. DTS, the Symbol, & DTS and the Symbol together are registered trademarks. DTS TruSurround is a trademark of DTS, Inc. © DTS, Inc. All Rights Reserved.

# SOUND MENU

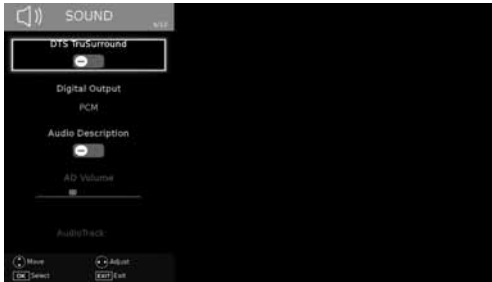

Digital Output - This is the digital optical audio output. Choose from the following options:

Off	To turn off Digital Output
Auto	Selects the best settings automatically
PCM	Select this option if you are connecting to a Stereo Hi-fi via optical cable (Pulse-code modulation (PCM) is a digital representation of an analogue signal)

Audio Description - This allows the user to switch Audio Description ON or OFF. (Audio Description is a service available on certain programmes. It provides a description of what is happening during the selected programme for a person who is visually impaired).

AD Volume - This allows the user to increase and decrease the AD (Audio Description) volume level.

# CHANNEL MENU

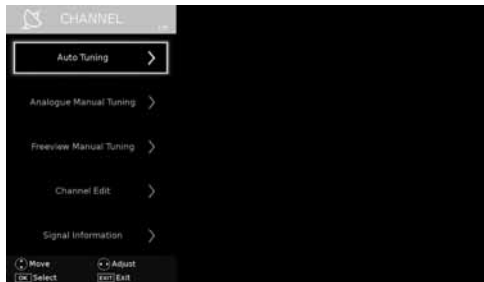

To access this menu, press [MENU] button on the remote control and scroll right.  
To select a sub menu press [OK]

If you wish to make changes to any of the default settings, use the scroll ▲▼▶◀ buttons.  
To confirm any settings press [OK] button. To exit this menu at anytime, press [EXIT] button.

**Auto Tuning** - Allows you to retune the television for all digital channels, digital radio stations and analogue devices.

**Analogue Manual Tuning** - Allows you to manually tune your analogue signal.

**Freeview/Saorview Manual Tuning\*** - Allows you to manually tune your digital signal.

**Channel Edit** - Allows you to delete, move, skip and select favourite channels.



**Important:** To receive Freeview/Saorview channels, in particular HD channels, you will need a Digital TV aerial and be in a good Freeview/Saorview coverage area. You can check the coverage for your area at [www.freeview.co.uk](http://www.freeview.co.uk) or [www.saorview.ie](http://www.saorview.ie)

Please note that any Freeview HD channels found during tuning will be placed in channel positions above 100.  
For example, 101 (BBC1 HD) 102 (BBC2 HD) etc.

\*Freeview channels are only available in the UK, Saorview channels are only available in the ROI.

**Signal Information** - Allows you to view signal frequency, signal quality and signal strength.

**CI Information** - Pay per view services require a "smartcard" to be inserted into the TV. If you subscribe to a pay per view service the provider will issue you with a 'CAM' and a "smartcard". The CAM can then be inserted into the COMMON INTERFACE PORT (CI Card In).

**Recorded List** - Shows a list of recorded TV programmes.

**Schedule List** - Lists your programme reminders.

**OAD (Software Update)** - Switch on/off OAD (over air download) software updates.

**Tip:** If you do not press any buttons for 30 seconds, the menu will automatically exit. You can change the length of time before the menu exits automatically - see 'OSD Timer' in the Time Menu

# SETTINGS MENU

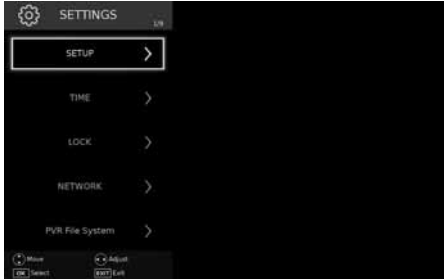

Set Up - Choose from the following options:

- Language - Allows you to change the language of the menu.
- Audio Language - Select your preferred primary audio language.
- Audio Language 2 - Select your preferred secondary audio language.
- Subtitle Language - Select your preferred primary subtitle language.
- Subtitle Language 2 - Select your preferred secondary subtitle language.
- Hearing Impaired - This allows the user to turn on the Hearing Impaired function, this produces subtitles on the screen which provide a description of what is happening during the selected program.
- Blue Screen - Changes the background when there is no input between clear and a blue background (Only available on some sources).
- LED Status - Allows the user to switch the LED power indicator light ON or OFF when the TV being operated. (When this option is set to OFF the LED power indicator light will flash when the remote control is used).
- First Time Installation - Allows you to access the First Time Installation menu and retune the TV set.
- Reset TV - This resets the menus to factory settings and clears all the TV channels from the television.
- Store Mode - switch ON/OFF shop demonstration mode (available only if store mode was selected during first time installation).

Time Menu - Choose from the following options:



- Auto Sync - When this option is set to ON the TV will automatically set the time, select OFF to access the 'Time' option and manually set the time.
- Time - Allows you to manually set the time, only available when Auto Sync is set to OFF.
- Off Time - Allows you to set a specific time for your TV to turn off.
- On Time - Allows you to set a specific time for your TV to turn on, the channel it will then display, the source it will be on and also the volume. This function can then be toggled to repeat every day or a certain day.
- Sleep Timer - Lets you set the sleep timer so the television automatically switches

off after a set amount of time. Off -> 10min -> 20min -> 30min -> 60min -> 90min -> 120min -> 180min -> 240min.

- OSD Timer - Lets you adjust the amount of time the On Screen Menu stays on the screen before disappearing. Off -> 5secs -> 15secs -> 30secs -> 60secs.
- Auto standby - Set 'Auto Standby' to OFF, 3 hours, 4 hours or 5 hours.
- Time Zone - Change your current time zone.

# SETTINGS MENU



Lock menu - Choose from the following options:

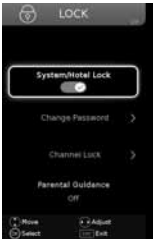

- System/Hotel Lock - Allows you to lock or unlock the menu. You will be asked to enter a 4 digit password Use the ◀ button to quit the password input or use the ▶ button to clear. Default password is 0000.
- Change Password - Allows you to change the password.
- Channel Lock - Allows you to lock certain channels manually.
- Parental Guidance - Allows you to set the rating to block certain content based on age information.
- TV Button Lock - Allows you to lock the buttons on the side of the TV set.

- Default Source - Allows the user to set the default source. The default source is the source the TV starts on when first switched on.
- Default Channel - Allows the user to set a channel as the default channel on the Digital source. The default channel is the channel the TV starts on when first switched on.
- Max Volume - Allows you to adjust and set the maximum volume.
- Source Lock - Allows you to lock the source menu.

Network menu - Choose from the following options:



The Network connection is only intended to access Pay TV services from your Freeview/Saorview broadcaster. Please note, the TV cannot be used for internet access.

For the network configuration to work the TV will need to be connected to your home network via an ethernet cable, with these requirements in place the TV will connect to the network automatically.

Choose from the following options:

- IP Config - Allows you to access LAN network connection settings. choose from the following options:

Auto	Will automatically connect the TV to your home network(this is the default setting and is highly recommended)
Manual	Allows you to manually change the IP, Netmask, Gateway and DNS information.

- Network Info - Allows you to view Information about network settings
- Network Test - Allows you to test the network connection.

# SETTINGS MENU



To access this menu, press [MENU] button on the remote control and scroll right.  
To select a sub menu press [OK]

If you wish to make changes to any of the default settings, use the scroll ▲▼▶◀ buttons.  
To confirm any settings press [OK] button. To exit this menu at anytime, press [EXIT] button.

PVR File System - PVR Recording options:

Select disk	Select USB port and disk partition
TimeShift Size	Set size time of shift buffer.
Format Start	You can format connected USB storage device to FAT 32 file system. <b>WARNING: ALL DATA ON THE USB DEVICE WILL BE DELETED</b>
Speed check	Tests write speed of connected USB storage devices.

HDMI CEC (Consumer Electronic Control) - Allows HDMI devices to control each other and allows the user to operate multiple devices with one remote control. (only available with compatible devices).

Software Update (USB) - Allows you to update your TV with the newest software using a USB memory stick. Software and instructions are available on our website.

Software Update (NET) - Allows you to update your TV with the newest software via your internet connection. This will require the TV to be connected to the internet and have a blank USB memory stick inserted in to the USB input of the TV. The software will be downloaded on to the blank USB memory stick and then complete the update process.

Version Info - Allows you to view the version/information of the software installed on the TV set.

**Note:** For further support with software updates, contact our technical support team or refer to the 'product support' section of the website. If the TV is using the newest software available it will not attempt to update the software.

# 7 DAY TV GUIDE

TV Guide is available in Saorview/Freeview TV mode. It provides information about forthcoming programmes (where supported by the Saorview/Freeview channel). You can view the start and end time of all programmes and on all channels for the next 7 days and set reminders.

1) Press [TV GUIDE] on the remote control, the following 7 Day TV Guide will appear.



2) Navigate through the menu using ▲▼▶◀

You can now:

Record a programme by pressing RED (USB device must be connected)

Set a reminder by pressing GREEN

View a previous day by pressing YELLOW

View the next day by pressing BLUE

3) Press [EXIT] to exit the 7 day TV Guide

## Channel List

To view the channel list, please ensure that the TV is set to either the analogue or digital source and no menus or TV notifications are displayed.

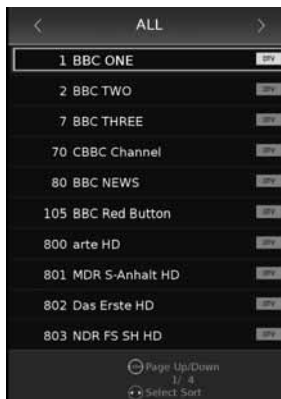

1) Press [OK] on the remote control and the channel list menu will appear.

2) Press LEFT / RIGHT arrow to filter desired channel types (Digital TV, Radio, All).

3) Scroll through the channel list by using ▲▼ buttons then press [OK] to view the channel that is currently highlighted.

4) Press [EXIT] to exit the channel list.

# DVD SETUP

Applies to TV models with built in DVD player only.



To enter this menu please ensure the TV is in DVD source & press [DVD SETUP]

If you wish to make changes to any of the default settings, use the scroll **▲▼▶◀** buttons. To confirm any settings press [OK] button. To exit this menu at anytime, press [DVD SETUP] button.

**TV Display** - Choose from the following options

4:3 Pan scan	PS Traditional picture format, often used on old film
4:3 Letter box	LB Traditional picture which has been adapted for widescreen
Wide	16:9 Widescreen picture format

**Speaker Setup** - Choose from the following options

LT/RT	Converts from multi-channel sound to mono
Stereo	Converts from multi-channel sound to stereo

**Dual Mono** - Choose from the following options

Stereo	Outputs 2 channels of sound both left and right
Mono L	Outputs left side sound
Mono R	Outputs right side sound
Mix Mono	Outputs a single channel of sound but mix between right and left

**Dynamic Range** - This is the difference between the quietest and loudest sounds. This setting works only with DVD discs recorded in Dolby digital.

Full	Set this to listen with the range recorded on the disc
3/4	Set this to listen with a range equivalent to a normal television
1/2	Set this to listen with a smaller difference between the maximum and minimum volume
1/4	Set this to listen with a smaller difference between the maximum and minimum volume
Off	Set dynamic range to off

**TV Type** - Choose from the following options

PAL	For discs from UK/Europe, Asia, Australia etc
Multi	For both NTSC and PAL
NTSC	For discs from North America, Japan etc

**Default** - Choose from the following options

Reset	Resets all options in the 'DVD setup' menu back to the default settings
-------	-------------------------------------------------------------------------

**Tip:** This TV/DVD player is pre-set to play Region 2 DVDs. In the event you wish to use the TV/DVD in another country that uses different region discs, please visit [www.umc-uk.co.uk](http://www.umc-uk.co.uk). Select 'Product Support', 'Changing Region'.



# USB RECORD - FREEVIEW/SAORVIEW MODE

Built into this television is a USB record facility. This function is available in Freeview/Saorview mode when used in conjunction with a compatible USB memory stick or USB hard drive. The benefits of this are as follows:

- Pause live TV and then playback, fast forward and rewind (up to live TV)
- One button record, if you decide you want to record the current programme
- Easy programmable recording from the 7 day TV Guide
- Record TV and watch/listen back on your computer/laptop

Due to the nature of the product, it is necessary to use a high speed USB memory stick (as the TV reads from and writes to the memory stick at the same time, some memory sticks may not be suitable)

You can purchase high speed memory sticks from some computer stores, alternatively, we have a selection of tested and compatible memory sticks available to purchase directly from the helpline/website.

Minimum specification - USB Memory Stick

Read Speed	80 Mb/s (Megabit Per Second)
Write Speed	40 Mb/s (Megabit Per Second)

If you wish to use a USB portable hard drive larger than 32GB, please refer to the FAQ section at the rear of this user guide.

## Pause live TV (time shift)

Pausing Live TV is very simple.



 - Press the play/pause button and the television will pause and the live content will be recorded. To resume watching press play/pause again.

 - Press fast forward to go forward in a recording (i.e. to skip adverts)

 - Press fast rewind to go back in a recording (i.e. if you fast forwarded too far)

**Tip:** When you switch the TV to standby or change channel the time shift memory is wiped. To restart time shift you must press play/pause button.

## One button record

At any point in time you may decide to record the current channel that you are watching. To do this you need to press the red button highlighted below.



**Tip:** This television contains one TV tuner, therefore it can only record the channel you are watching or record one channel while the television is in standby mode.

**Note:** USB record function is only available in Freeview/Saorview TV mode. Due to copyright laws and illegal copying/recording it is not possible to record to/from any other input/output source.

# USB MODE/MEDIA PLAYER

USB mode offers playback of various different types of content that you have saved on your USB Memory Stick.

On switching to USB source the below menu screen will appear. The content will be divided into Photo, Music, Movie and Text based on file type.

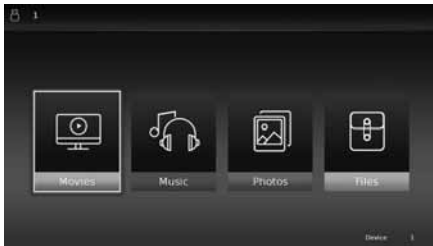

1) You can navigate through the menus using the scroll ▲▼▶◀ buttons on the remote control, to confirm the item you wish to play/view press the [OK] button.



2) Select the drive you require. (If your drive only has 1 partition you will only see 1 item).

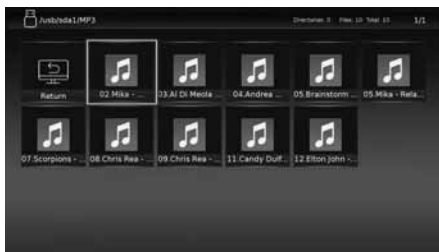

3) You can now access the item. Press OK to view.



4) Whilst viewing your media, you can control the item by using the remote control buttons (below) or by pressing (Info) to access the on-screen playback menu, you can now make your selection by using the ▲▼▶◀ and (OK) buttons on the remote control.

Fig.A



**Tip:** If you experience a playback issue, please ensure the files being used are the correct format (example - the picture plays but no sound) See technical specification page for compatible file types

**Note:** USB extension cables are not recommended as they can cause a reduction in picture/audio quality and stoppages during play back of USB content.

# FREQUENTLY ASKED QUESTIONS

General	I would like to have louder sound by connecting additional speakers. For TV models with digital optical audio output.	<p>1) Use the 3.5mm headphone output and a 3.5mm to phono cable (available separately) to connect to an amplifier/surround sound system. Please note this will deactivate the TV's built in speakers.</p> <p>2) Connect a digital optical audio cable from the TV's digital optical audio output to your amplifier/surround systems digital optical audio input.</p>
General	Why are some options in the menu unavailable and greyed out.	Some options are only available in certain sources, i.e. HDMI. They are unavailable in the other sources where they have no affect.
General	Can I stop my TV automatically turning off after 4hrs?	Yes, in the 'Time' menu settings, scroll down to Auto standby and select OFF.
TV	I have tuned in Digital TV but I am not receiving any or all of the channels and/or the channels I receive are breaking up.	<p>1) Check you are in an area that can receive Freeview/Saorview, visit <a href="http://www.freeview.co.uk">www.freeview.co.uk</a> or <a href="http://www.saorview.ie">www.saorview.ie</a></p> <p>2) Check you are using an aerial that is able to receive a good digital signal. In most cases, you will need an outdoor digital hi-gain/wideband aerial. In areas that have excellent digital coverage, you may be able to use a loft type aerial but it is highly likely that you will also need to connect a booster between the back of the TV and the TV aerial wall socket. Unfortunately, to receive a good enough digital signal, it is not possible to use a portable/indoor type aerial.</p>
TV	I have re-tuned my television but when I switch it off it is not storing the channels.	<p>If the TV does not save the channels when you power it off, it's likely the channel database has become corrupt.</p> <p>1) Turn off the TV.</p> <p>2) Remove the RF/Aerial cable from the rear of the TV and then turn the TV back on again.</p> <p>3) Using the remote control, press Menu followed by 8-8-8-8 to enter the initial setup/first time installation menu.</p> <p>4) Press OK (let the TV run the full tuning process).</p> <p>5) Once completed, turn off the TV, reconnect the RF/Aerial cable then turn the TV back on again.</p> <p>6) Repeat steps 3 &amp; 4.</p>
VCR/DVD Recorder	I have connected the TV to my VCR or DVD Recorder via SCART but it is not recording.	In addition to connecting via SCART, you should connect the aerial cable from the wall socket to your VCR/DVD Recorder and another aerial cable from the VCR/DVD Recorder to the TV.
Game Consoles	I have connected my Playstation/ Xbox to the TV via HDMI, but I am not receiving any pictures or sound on my TV	<p>1) Ensure the TV's source is set to HDMI.</p> <p>2) Check your settings on your Playstation/Xbox are as per the Playstation/Xbox instruction manual.</p>
Game Consoles	I have connected my Playstation/ Xbox to the TV via Component cables (red, green & blue) but I am not receiving any sound.	Component cables only provide HD pictures. For the sound you will need to connect the red & white audio cables on the Playstation/Xbox to the red & white phono inputs (or mini AV input where fitted) on the rear of the TV. Please refer to the 'Connections' pages.
System Lock	I have changed the password on the television and now forgotten it.	There is a master password of 4711, to gain access to the TV menu and reset the normal password.
Freeview HD	I cannot access all Freeview channels.	Some data channels for Freeview can only be obtained when the TV's ethernet port is connected to your router.
Freeview HD	I cannot find the Freeview HD channels.	Freeview HD channels found during tuning will be placed in channel positions above 100. For example, 101 (BBC1 HD), 102 (BBC2 HD) etc.

# FREQUENTLY ASKED QUESTIONS

USB Mode	I have inserted a USB Memory Key, but the TV does not recognise it.	Ensure the USB Memory Key is formatted to type FAT32.
USB Mode	Using a USB portable hard drive / larger than 32GB.	If you wish to use a portable hard drive larger than 32GB, please note that it must be formatted to the FAT32 file system in order to operate on this TV. Windows XP/Vista computers are only capable of formatting up to 32GB, therefore, you will need a software programme/utility to format larger hard drives. Please refer to the website, <a href="http://www.umc-uk.co.uk">www.umc-uk.co.uk</a> , for more information.
USB Record	I cannot change the channel, access the menu or use the red button.	During time shift you cannot change the channel, access the menu or use the red button.
USB Record	When using the USB to record the picture 'breaks up' or experience loss of sound.	Check the USB memory stick meets the minimum read speed requirements. Standard definition channels require a read speed of 20 MB/s (Mega Byte per second) and a write Speed of 6 MB/s (Mega Byte per second) HD channels require the read speed of 80 MB/s (Mega Byte per second) and a write speed of 40 MB/s (Mega Byte per second). USB 3.0 sticks should be used where possible.
Pairing the remote control	Remote control does not work with the TV set when first time installation is on the TV screen	During first time installation press and hold the YELLOW and BLUE buttons on the remote control for a few seconds. The power light will blink 5 times to confirm the TV and remote control are paired.
Pairing the remote control	Remote control does not power on the TV set	Switch the TV on by pressing the TV control stick once, this is located on the back of the TV in the left bottom corner. Once switched on, press and hold the TV control stick on the TV set for a few seconds. This will prompt the 'pairing menu' to appear, scroll through and highlight the 'Pair your remote' option by pressing the TV control stick up or down, then press the control stick to confirm your selection. Then with the remote control, press and hold the YELLOW and BLUE buttons for a few seconds, the power light will blink 5 times to confirm the TV and remote control are paired.

# TECHNICAL SPECIFICATION

## Product fiche

<b>Trademark</b>	<b>Sharp</b>
<b>Model ID</b>	<b>LC-32CHG4041K</b>
Energy efficiency class	A+
Visible screen size (diagonal)	81 cm / 32 inches
On mode power consumption	31.0 W
Annual energy consumption *1	45 kWh
Standby power consumption *2	<0.50 W
Off mode power consumption	n/a
Screen resolution	1366 (H) x 768 (V)
<p>*1: Energy consumption XYZ kWh per year, based on the power consumption of the television operating 4 hours per day for 365 days. The actual energy consumption will depend on how the television is used.</p> <p>*2: When the TV is turned off with the remote control/standby button and no function is active.</p>	

## Additional Technical Information

Tuner	75 ohm Antenna / Analog / DVB-T2
Inputs	3 x HDMI, 2 x USB, 1 x SCART, 1 x RJ45 (Ethernet), 1 x Mini Component/YPbPr, 1 x Mini Composite/Video & L/R Audio shared for Composite/Video & Component/YPbPr
Sound Outputs	1 x 3.5mm Headphone, 1 x Optical digital audio out
Speaker / Sound Watts (RMS)	2 x 10 / 2 x 8
Voltage and power consumption	AC 220V ~ 240V; 50/60Hz 31/45/70W (home mode/standard/max) (<0.5W in Standby)
Dimensions including stand (mm)	732W x 467H x 160D
Net weight (Kgs)	5.3
Wall Mounting	VESA 200 x 200 (mm)

# TECHNICAL SPECIFICATION

## Product fiche

<b>Trademark</b>	<b>Sharp</b>
<b>Model ID</b>	<b>LC-32DHG4041K</b>
Energy efficiency class	A+
Visible screen size (diagonal)	81 cm / 32 inches
On mode power consumption	31.0 W
Annual energy consumption *1	45 kWh
Standby power consumption *2	<0.50 W
Off mode power consumption	n/a
Screen resolution	1366 (H) x 768 (V)
<p>*1: Energy consumption XYZ kWh per year, based on the power consumption of the television operating 4 hours per day for 365 days. The actual energy consumption will depend on how the television is used.</p> <p>*2: When the TV is turned off with the remote control/standby button and no function is active.</p>	

## Additional Technical Information

Tuner	75 ohm Antenna / Analog / DVB-T2
Inputs	3 x HDMI, 2 x USB, 1 x SCART, 1 x RJ45 (Ethernet), 1 x Mini Component/YPbPr, 1 x Mini Composite/Video & L/R Audio shared for Composite/Video & Component/YPbPr
Sound Outputs	1 x 3.5mm Headphone, 1 x Optical digital audio out
Speaker / Sound Watts (RMS)	2 x 10 / 2 x 8
Voltage and power consumption	AC 220V ~ 240V; 50/60Hz 31/45/80W (home mode/standard/max) (<0.5W in Standby)
Dimensions including stand (mm)	732W x 467H x 160D
Net weight (Kgs)	5.5
Wall Mounting	VESA 200 x 200 (mm)

# TECHNICAL SPECIFICATION

## Product fiche

<b>Trademark</b>	<b>Sharp</b>
<b>Model ID</b>	<b>LC-40CFG4041K</b>
Energy efficiency class	A+
Visible screen size (diagonal)	100 cm / 40 inches
On mode power consumption	45.0 W
Annual energy consumption *1	66 kWh
Standby power consumption *2	<0.50 W
Off mode power consumption	n/a
Screen resolution	1920 (H) x 1080 (V)
<p>*1: Energy consumption XYZ kWh per year, based on the power consumption of the television operating 4 hours per day for 365 days. The actual energy consumption will depend on how the television is used.</p> <p>*2: When the TV is turned off with the remote control/standby button and no function is active.</p>	

## Additional Technical Information

Tuner	75 ohm Antenna / Analog / DVB-T2
Inputs	3 x HDMI, 2 x USB, 1 x RJ45 (Ethernet), 1 x SCART, 1 x Component/YPbPr, 1 x Composite Video/CVBS, 1x L/R Audio shared for Composite Video/CVBS & Component/YPbPr
Sound Outputs	1 x 3.5mm Headphone, 1 x Optical digital audio out
Speaker / Sound Watts (RMS)	2 x 10 / 2 x 8
Voltage and power consumption	AC 220V ~ 240V; 50/60Hz 45/65/80W (home mode/standard/max) (<0.5W in Standby)
Dimensions including stand (mm)	921W x 572H x 184D
Net weight (Kgs)	7
Wall Mounting	VESA 200 x 300 (mm)

# TECHNICAL SPECIFICATION

## Compatible files

Media	File Ext.	Codec		Remark
		Video	Audio	
MOVIE	.mpg	MPEG-1, MPEG-2	MP3, AAC, AC3, PCM,	<b>Max Resolution:</b> 1920x1080
				<b>Max Data Rate:</b> 40 Mbps
	.avi	Xvid, MJPEG		<b>Max Resolution:</b> 1920x1080 <b>Max Data Rate:</b> 20 Mbps
		MPEG-4 SP/ASP, H.263/H.264		
	.ts	MPEG-2, H.264, HEVC		
	.mov .mkv	MPEG-4 SP/ASP, H.263/H.264, HEVC		
		.dat		
	.mp4	MPEG-4 SP/ASP, H.263/H.264, HEVC		
MPEG-1, MPEG-2		<b>Max Resolution:</b> 720x576 <b>Max Data Rate:</b> 40 Mbps		
.vob	MPEG-2			
MUSIC	.mp3	--	MP3	<b>Sample Rate:</b> 8K~48KHz <b>Bit Rate:</b> 32K~320Kbps
	.m4a/.aac	--	AAC	<b>Sample Rate:</b> 16K~48KHz <b>Bit Rate:</b> 32K~442Kbps <b>Channel:</b> Mono/Stereo
PHOTO	.jpg/	Progressive JPEG		<b>Max Resolution:</b> 1024x768
	.jpeg	Baseline JPEG		<b>Max Resolution:</b> 15360x8640
	.bmp	BMP		<b>Max Resolution:</b> 9600x6400 <b>Pixel Depth:</b> 1/4/8/16/24/32 bpp
		.png	Non-Interlaced	
	Interlaced		<b>Max Resolution:</b> 1280x800	
SUBTITLE	.srt	SubRip		
	.ssa/.ass	SubStation Alpha		
	.smi	SAMI		
	.sub	SubViewer MicroDVD DVDSubtitleSystem SubIdx(VobSub)		SubViewer 1.0 & 2.0 Only
	.txt	TMPlayer		



UMC Poland sp. z o.o.

Ostaszewo 57B, 87-148 Łysomice,  
Poland

Assembled in Europe

**This is Why**

[www.sharp.eu](http://www.sharp.eu)

**SHARP**

**CE**



SHA/MAV/0214