

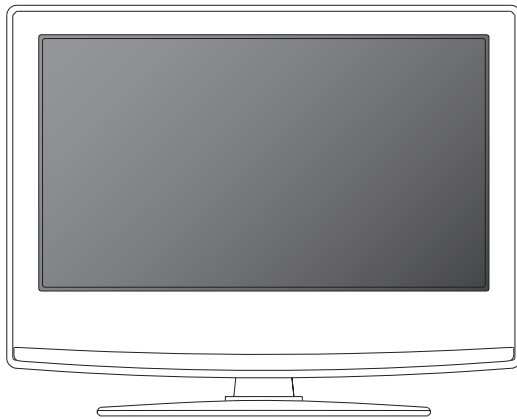

SMART LED TV with Freeview, Saorview, DVD Player & USB PVR

## User Guide



Model No

32/148M-GB-11B-EGPX-UK

40/148M-GB-11B-FEGPX-UK

## Important safety instruction



**Please read these instructions. All the safety and operating instructions should be read before the appliance is operated.**

### Warnings

- Television sets with 40" screens or more must be lifted and carried by at least 2 people.
- This television does not contain any parts that are serviceable by the user. In case of a fault, contact the manufacturer or authorised service department. Exposing the internal parts inside the TV may endanger your life. The manufacturer's guarantee does not extend to faults caused by repairs carried out by unauthorised third parties.

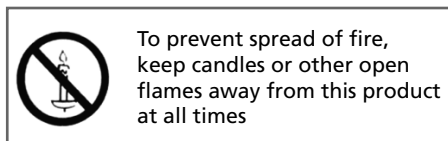

- Do not use TV set immediately after unpacking. Wait until TV warms up to the room temperature before using it.
- Do not use TV set immediately after unpacking. Wait until the TV warms up to the room temperature before using it.
- To reduce the risk of fire, electric shock or damage to the TV, do not expose it to dust, rain or moisture. Never expose the TV to dripping or splashing and do not place objects filled with liquids on or near the TV.
- Do not connect any external devices (DVD player, games console etc) when the TV is switched on. Disconnect both the TV and device from the mains before connecting. Only switch appliances on when the connection process is complete.
- Do not place the television in a confined space and do not obstruct the ventilation openings at the rear of the television.
- When installing on a wall, ensure the TV is at least 5cm from the wall for ventilation.
- Always ensure that the TV's ventilation openings are not covered with items such as newspapers, tablecloths, curtains, etc.
- Dispose of this television and any components including batteries in an environmentally friendly manner. If in doubt, please contact your local authority for details of recycling.
- Ensure this TV is used in moderate climates only.
- In case of electrostatic discharge (ESD) the TV may display incorrect functions. In such case, switch the TV off and switch the TV back on. The TV will work normally.

**WARNING: Never place a television set on an unstable location. A television set may fall, causing serious personal injury or death. Many injuries, particularly to children, can be avoided by taking simple precautions such as:**

- Use cabinets or stands recommended by the manufacturer of the television set.
- Only use furniture that can safely support the television set.
- Ensure the television set is not overhanging the edge of the supporting furniture.
- Do not place the television set on tall furniture (for example, cupboards or bookcases) without anchoring both the furniture and the television set to a suitable support.
- Do not place the television set on cloth or other materials that may be located between the television set and supporting furniture.
- Please educate children about the dangers of climbing on furniture to reach the television set or its controls.
- If your existing television set is being retained and relocated, the same considerations as above should be applied.

### Safety

- For your safety, this appliance is fitted with a fused 3 pin mains plug. Should the fuse need to be replaced, ensure that any replacement is of the same amperage and approved with the BSI mark.
- Never try and replace the mains plug unless you have adequate qualifications and are legally authorised to do so. In the event that a replacement mains cable is required, contact the manufacturer for a suitable replacement.
- Never use the television if it is damaged in any way.
- Always place the television on a flat level surface avoiding anywhere which may be subject to strong vibration.
- The ideal distance to watch the television is approximately five times the length of the diagonal measurements of the TV screen.
- Ensure the television is not placed on top of the power cable as the weight of the television may damage the cable and cause a safety hazard.
- Never place mobile phones, speakers or any other device which may cause magnetic or radio interference, near the television. If interference is apparent, move the device causing the interference away from the television.
- To disconnect the set from the mains, remove the mains plug from the socket.
- Ensure that the mains plug is always easily accessible.

**WARNING: Excessive noise when using earphones and headphones can cause loss of hearing.**

## Important safety instruction



### Maintenance

- To clean your TV, wipe with a soft, dry cloth. If the surfaces are extremely dirty, use a soft cloth dipped in a soap and water solution or a weak detergent solution.
- Never use alcohol, paint thinner or benzene to clean this unit.
- Before using a chemically treated cloth, read the instructions that came with the cloth carefully.

**CAUTION: If water or other liquid enters the television through the display panel surface, a malfunction may occur.**



### Packaging

- The safest way to transport your item is in the original box/packaging - please save your packaging for this.
- You will need the original box/packaging in the event of warranty/service repair or support. We are unable to carry out warranty/service if you are unable to package the item correctly.

### Important information regarding use of video games, computers, captions or other fixed image displays

The extended use of fixed image program material can cause a permanent "shadow image" on the LCD/LED panel, also known as "screen burn".

This "shadow image" can appear in the background during normal viewing. This type of irreversible LCD/LED panel deterioration can be limited by observing the following steps:

1. Reduce the brightness/contrast setting to a minimum suitable viewing level.
2. Do not display the fixed image for extended periods of time.
3. Turn the power off when not in use.

Examples of images that are more likely to cause "screen burn" are as follows (this is not an exhaustive list):

- TV channel logos: e.g. shopping channel logos and pricing displays - especially if they are bright and stationary. Moving or low-contrast graphics are less likely to cause ageing of the screen.

- Time displays.
- Teletext: Do not view a stationary page for a long period of time
- TV/DVD menus: e.g. listings of DVD disc content.
- Pause mode: Do not leave the TV in pause mode for long periods of time, e.g. when watching DVDs or videos.

**Important: Once 'shadow image/screen burn' occurs, it will never disappear and is not repairable under warranty.**

### How do I dispose of this product?

**UK:** Waste electrical products should not be disposed of with household waste. Please dispose of the product at a designated collection point for recycling of WEEE. For your nearest facilities, please see [www.recycle-more.co.uk](http://www.recycle-more.co.uk) or in store for details.



**ROI:** Waste electrical products should not be disposed of with household waste. Separate disposal facilities exist. Check with your local authority or retailer for recycling advice.



### Batteries

- Do not expose batteries to high temperatures, excessive heat, prolonged sunshine or fire as this may cause leakage, explosion or ignition. Observe the correct polarity when inserting batteries.
- Do not use different types of batteries together or mix old and new batteries.
- Dispose of batteries in an environmentally friendly way.
- Certain regions may regulate the disposal of batteries. Please consult your local authority.

Cd

---

## Trademarks



The terms HDMI and HDMI High-Definition Multimedia Interface, and the HDMI Logo are trademarks or registered trademarks of HDMI Licensing, LLC in the United States and other countries.

### HDTV

The "HD TV" Logo is a trademark of DIGITALEUROPE.

### HDTV 1080p

The "HD TV 1080p" Logo is a trademark of DIGITALEUROPE.

### DVB

The DVB logo is the registered trademark of the Digital Video Broadcasting (DVB) project.



DOLBY  
AUDIO

Manufactured under license from Dolby Laboratories. Dolby, Dolby Audio and the double-D symbol are trademarks of Dolby Laboratories.



The "CI plus" Logo is a trademark of CI Plus LLP.

### Youtube

YouTube and the YouTube logo are trademarks of Google Inc.

### FREEVIEW HD

The FREEVIEW HD words and logos are trade marks of DTV Services LTD. © DTV Services Ltd.

### SAORVIEW

SAORVIEW is a registered trademark owned by RTÉ.

### Miracast

Wi-Fi CERTIFIED Miracast and Miracast are trademarks of Wi-Fi Alliance.

### DLNA

DLNA, the DLNA Logo and DLNA CERTIFIED are trademarks, service marks, or certification marks of the Digital Living Network Alliance.



For DTS patents, see <http://patents.dts.com>. Manufactured under license from DTS Licensing Limited. DTS, the Symbol, & DTS and the Symbol together are registered trademarks. DTS TruSurround is a trademark of DTS, Inc. © DTS, Inc. All Rights Reserved.

#### CE Statement:

Hereby, Universal Media Corporation l.t.d. declares that this LED TV is in compliance with the essential requirements and other relevant provisions of RED Directive 2014/53/EU.

---

# CONTENTS

---

Manufacturers Guarantee Information . . . . .	3
Important Safety Instructions . . . . .	4-5
Trademarks . . . . .	6
What is Included in the Box . . . . .	8
Attaching the Stand / Detaching the Stand . . . . .	9
Securing the TV to a Wall / Wall Mounting . . . . .	10
Remote Control . . . . .	11
TV Buttons and Input Source Menu . . . . .	12
Connections . . . . .	13-15
7 Day TV Guide and Channel List . . . . .	16
Connecting the TV to the Internet . . . . .	17
TV Menu Operation . . . . .	18-29
Picture Menu . . . . .	18-19
Sound Menu . . . . .	20-21
Channel Menu . . . . .	22
Network Menu . . . . .	23
Time Menu . . . . .	24
Lock Menu . . . . .	25
Setup Menu . . . . .	26
More Apps Menu . . . . .	27-28
Media Menu . . . . .	28-29
USB Record - Freeview / Saorview . . . . .	30
General Information . . . . .	31-36
Using your TV with a Sky digital set top box . . . . .	31
Frequently Asked Questions . . . . .	32-33
Technical Specifications . . . . .	34-36

# WHAT IS INCLUDED IN THE BOX

## Accessories

Included with this TV are the following accessories

1 x User Guide

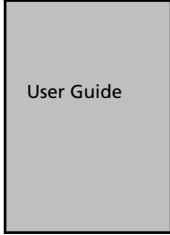

1 x Remote Control and 2 x AAA Batteries



1 x Quick Start Guide



1 x Mini Component / YPbPr



1 x Mini AV / Composite cable



1 x TV



1 x SCART to Mini-SCART adapter



1 x Stand installation pack

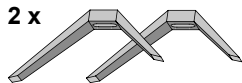

Please save your box/packaging as you will need this in the event of warranty/service repair or support. We are unable to carry out warranty/service if you are unable to package it correctly. The safest way to package your item in the event of warranty/service repair is in it's original box/packaging.

# ATTACHING THE STAND

## Attaching the stand feet

To complete the stand feet installation you will require a cross head screw driver.

Screws that are included.

4 x 

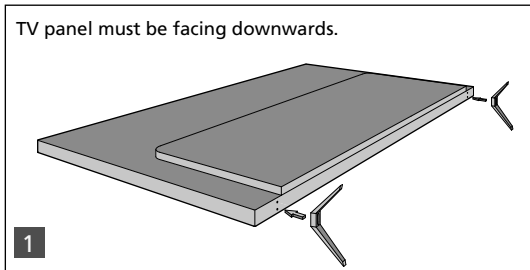

**(fig.1)** Place the TV set on a flat and clean surface with the panel facing downwards to avoid damage, then fix the stand feet shown.

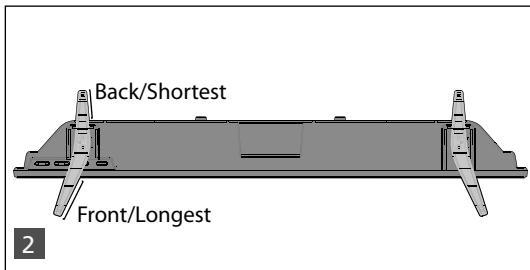

**(fig.2)** When the stand feet are installed correctly the stand feet will be longest at the front of the TV and shortest at the back with the feet pointing away from each other.

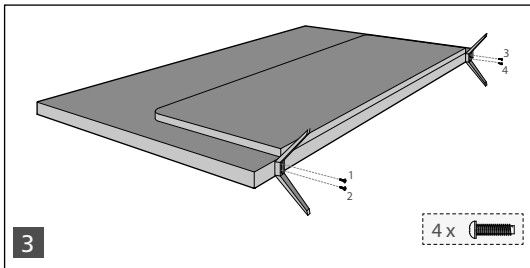

**(fig.3)** When the stand feet are in the correct position, secure the stand feet to the underside of the TV set using the 4 screws provided.

## Detaching the stand

Remove the screws highlighted then remove the stand feet from the underside of the TV set.

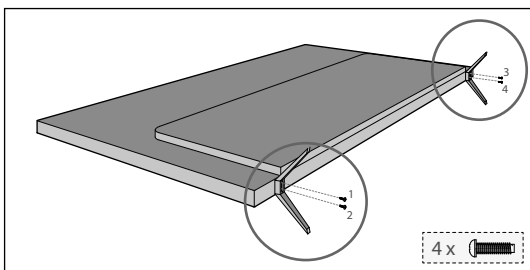

# SECURING THE TV TO A WALL

## Securing the TV to a wall with anti-tip straps

For maximum security in the home when using a TV with its stand anti-tip straps should be fitted. These are available from supermarket websites and other websites and are an easy, inexpensive and effective way of ensuring your TV stays safely upright. Straps are designed to be attached to the rear of the TV and then tethered to the wall or the furniture the TV is stood on.

**Note - Please ensure that children do not climb on the TV set.**

**A)** Using one or both of the top wall-mounting holes and screws (the screws are already supplied in the wall mounting holes) fasten one end of the fastening cord/s to the TV.

**B)** Secure the other end of the fastening cord/s to your wall. (you will need screws/fixings suitable for your wall type - available separately from most DIY stores).

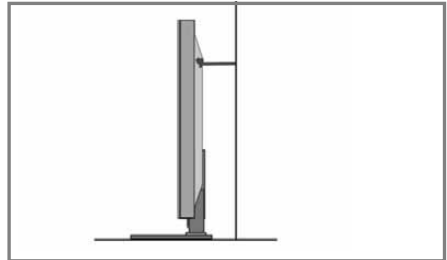
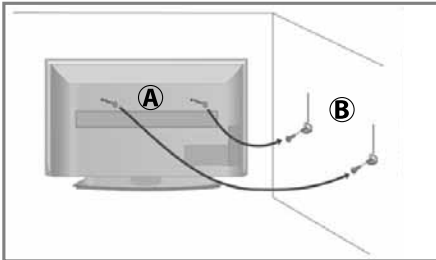

The Royal Society for the Prevention of Accidents is urging people to take care with flat-screen televisions. RoSPA stated in 2010 that "Toddlers are particularly at risk of pulling flat-screen televisions on to themselves. They are unsteady on their feet and are attracted by colourful television images." The risk is increased as televisions become lighter.

## Wall Mounting

**IMPORTANT - Before drilling any holes in the wall ensure you are not drilling where there could be any electrical wires, water or gas pipes.**

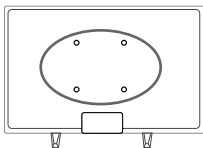

- 1) Remove the four screws highlighted that are supplied in the wall mounting holes.
- 2) The wall mount can now be easily attached to the mounting holes on the rear of the TV.

For VESA wall mounting information please refer to the Technical Specification page.

For optimum viewing, if wall mounting the TV higher than eye level, the TV should be tilted downwards so that the TV's screen is 'face on'. See fig 1 and 2.

fig 1 INCORRECT

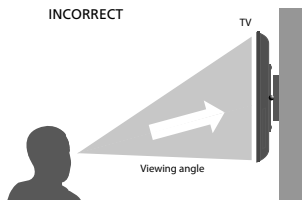
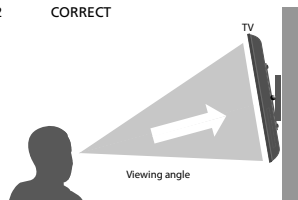

fig 2 CORRECT







**Important - If wall mounting this TV, only use the screws already provided in the wall mounting holes. Using other screws which are longer could cause irreparable damage to internal parts. When using a wall bracket, please ensure the screws in the back of the TV set are not over tightened.**



# REMOTE CONTROL















## Key

-  For models with integrated DVD players.
-  For models with PVR Function.
-  For models with USB Playback.
-  For models with 3D functions.

**1** **ON/OFF** - Switch on the TV when in standby or vice versa.  
**MUTE** - Mute the sound or vice versa.

**2** **NUMBER BUTTONS** - 0-9 to select a TV channel directly.  
**TV GUIDE** - Opens the 7 day TV guide (digital TV mode).  
 - To return to the previous channel viewed.

**3** **VOL (+/-)** - To increase/decrease the sound level.  
**PICTURE** - Scrolls through picture mode options.  
**SOUND** - Scrolls through sound mode options.  
**SOURCE** - To display the input/source menu.  
**CH (+/-)** - To increase or decrease the channel being watched.  
**MENU** - To display OSD menu.  
**EXIT** - To exit all menus.  
**(▲/▼/◀/▶/OK)** - Allows you to navigate the on-screen menus and adjust the system settings to your preference.  
**BACK** - To go back a previous step.  
**FAV** - To display favourites menu.

**4** **INFO** - Press once for now/next channel information.  
 - Press twice for information about the current programme.  
**TEXT** - To enter/exit Text.  
**SUBTITLE** - To switch the dialogue at the bottom of the screen (on/off).  
**TV** - To switch to Digital Channels.  
**YOUTUBE** - Access the Youtube App.  
**NETFLIX** - Access the Netflix App.  
**SMART** - Access the Blaupunkt Smart Portal.  
 **RECORD** - Access the USB record function.  
 **REC LIST** - Opens the list of what has been previously recorded.  
 - To restart the current chapter  
 - To advance forward to the next chapter  
 /  - To stop the playback/Eject Disc  
 (To EJECT the disc press/hold the  button for 4 seconds)  
 - To play in fast rewind mode  
 - To play in fast forward mode  
 - To play/pause  
 **GOTO** - To go to a specific chapter.  
 **A-B** - Press once to set point, press a second time to return to point.  
 **ANGLE/3D** - Select different angle of DVD.  
 **REPEAT** - To repeat playback.



# TV BUTTONS AND INPUT SOURCE MENU

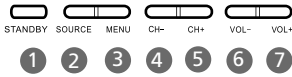

- 1 Standby Power On/Off
- 2 Displays the input source menu
- 3 Displays Menu/OSD
- 4 Programme/Channel down and menu down
- 5 Programme/Channel up and menu up
- 6 Volume down and menu left
- 7 Volume up and menu right

## Choosing Mode Input/Source

To switch between the different input/connections.

For further information on input/connections please view 'Connections' pages.

A) Using the buttons on the remote control:

- 1) Press [SOURCE] - The source menu will appear.
- 2) Press [<] or [>] to select the input you require.
- 3) Press [OK].

B) Using the buttons on the Television:

- 1) Press [SOURCE].
- 2) Scroll right / left using VOL+ / VOL- buttons to the input/source you require.
- 3) Press [SOURCE] to change input/source to the one selected.



An example of the 'Input Source' menu (will vary by model)

# CONNECTIONS

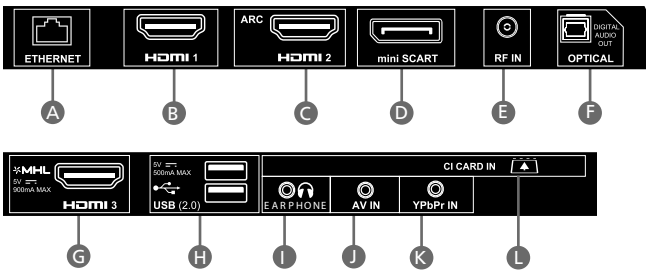
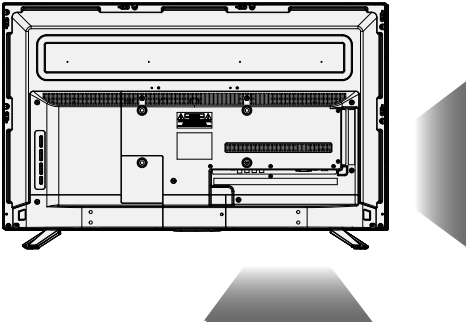

A	Ethernet/LAN*	Network Connection
B	HDMI 1	HDMI input
C	HDMI 2 (ARC)	HDMI input
D	SCART	SCART input
E	RF IN	RF / TV Aerial Input
F	Optical Digital Audio	Digital Audio output

G	HDMI 3 (MHL)**	HDMI input
H	2 x USB	USB port
I	Earphone	Earphone output
J	AV IN	Audio/Video Input
K	YPbPr	HD input (Ypbpr)
L	CI CARD IN	Common Interface module

\* The Ethernet/LAN port is used for Freeview HD services and smart functions.

\*\* **HDMI 3 (MHL Port)** - MHL is a wired solution that allows you to access the media from your phone or tablet onto the big screen in the highest quality.

By connecting an MHL cable (sold separately) from your mobile device and into your TV you can playback all your videos, games and photographs directly onto your TV.

MHL simply mirrors the screen of your mobile device so will work with all applications, whilst connected it will also charge your device too.

# CONNECTIONS

Note: Connecting cables are shown for example only and may not be included. Please check 'What Is Included In The Box' page.

## Connecting to a device with Composite AV/Video output

TV Source should be set to Composite/AV.

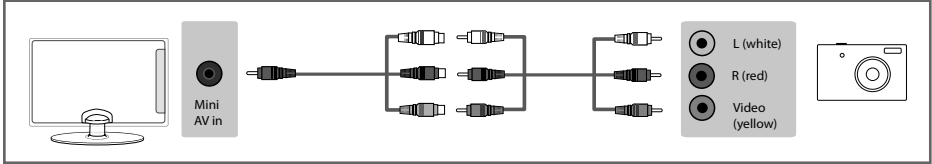

## Connecting to a device via Mini-SCART output

TV source should be set to SCART.

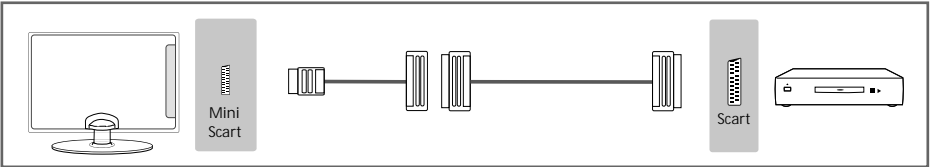

## Connecting to a device with HDMI output

A HDMI cable can output both video and audio and enables you to enjoy digital-quality video and audio with minimal loss of quality.

TV Source should be set to the corresponding HDMI port (HDMI 1, HDMI 2 etc)

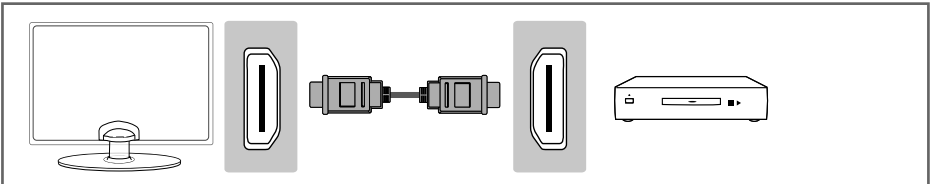

**HDMI 3 (MHL Port)** - MHL is a wired solution that allows you to access the media from your phone or tablet onto the big screen in the highest quality. By connecting an MHL cable (sold separately) from your mobile device and into your TV you can playback all your videos, games and photographs directly onto your TV. MHL simply mirrors the screen of your mobile device so will work with all applications, whilst connected it will also charge your device too.

# CONNECTIONS

## Connecting to a device with Component/YPbPr output

If you are supplied with a cable from the device which has RED, GREEN, BLUE, RED & WHITE connectors you must connect via Component (for picture) and by phono cable (for sound).

TV Source should be set to Component/YPbPr

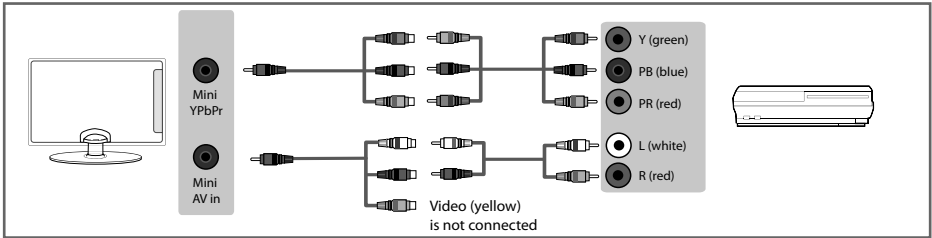

## Connecting to an external audio device (Amplifiers, Surround Sound, Sound Bars etc)

When connecting via the TV's 3.5mm Earphone output, this will disable the TV speakers.

There are two options when connecting a device via the 3.5mm Earphone Output and the Digital Optical Audio Output

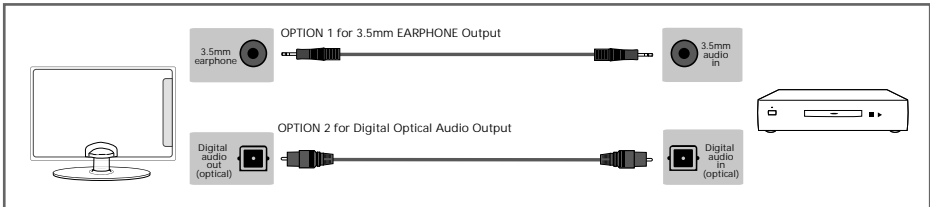

## Connecting an Ethernet/Network cable

The Ethernet/LAN port is used for Freeview HD services and smart functions.

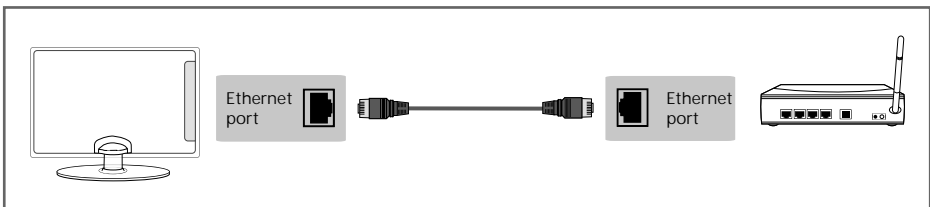

# 7 DAY TV GUIDE

TV Guide is available in Freeview TV mode. It provides information about forthcoming programmes (where supported by the Freeview channel). You can view the start and end time of all programmes and on all channels for the next 7 days and set reminders.

1) Press the [TV GUIDE] button on the remote control and the following 7 Day TV Guide will appear:

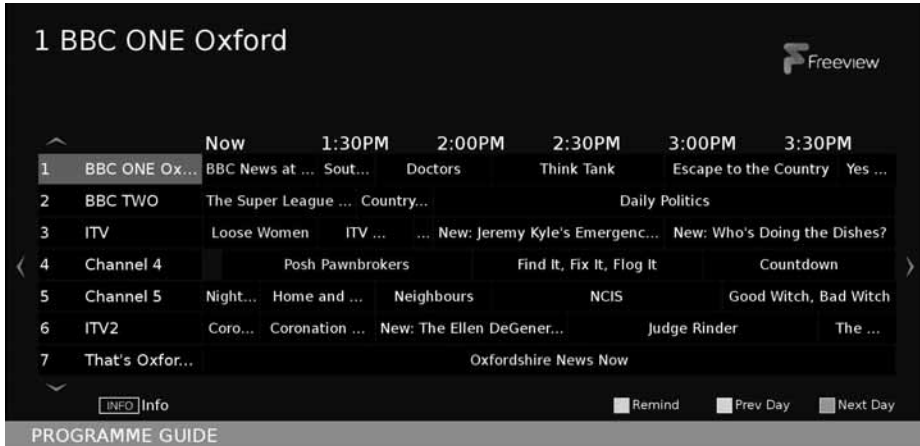

2) Navigate through the menu using ▲▼▶◀

You can now:

View the next day by pressing BLUE

View a previous day by pressing YELLOW

Set a reminder by pressing GREEN

Record a programme by pressing RED (Function for PVR models only, USB device must be connected)

View further information about the programme by pressing INFO

3) Press [EXIT] to exit the 7 day TV Guide

## Channel List

To view the channel list, please ensure that the TV is set to either the analogue or digital source and no menus or TV notifications are displayed.



1) Press [OK] on the remote control and the channel list menu will appear.

2) Scroll through the channel list by using ▲▼ buttons then press [OK] to view the channel that is currently highlighted.

3) Scroll through different types of channels such as Freeview/ALL/Digital TV/Radio/data and HD channels by using ◀ ▶ buttons.

4) Press [EXIT] to exit the channel list.

# CONNECTING THE TV TO THE INTERNET

When you first power on your new SMART TV there will be an option to follow various on-screen set up instructions. These instructions will enable you to connect to the internet via your home network. You can connect to your home network either wirelessly or with an Ethernet cable.

If you decide not to follow the initial set up instructions and need to connect at a later date please follow these simple steps below:

## Connecting your TV with a wireless connection

- 1) Press Menu on the remote control (fig.1).
- 2) Scroll through the menu, select and enter 'Settings' then enter the 'Network' menu.
- 3) In the 'Network' menu, example below, scroll down and select 'Wi-Fi Config' (fig.2).
- 4) Within the 'Wi-Fi config' options, highlight and select 'Wi-Fi Auto Search'.
- 5) The TV will then automatically search for networks.
- 6) Select the preferred type of network connection then enter the network password.
- 7) The TV will then establish a connection.

**Note:** An icon will appear in the top right hand side of the 'Application' menu to show you if the TV is connected to the internet.

## Connecting your TV with an Ethernet/LAN cable:

- 1) Plug in your Ethernet cable into the RJ45 (Ethernet) socket located at the rear of the television.

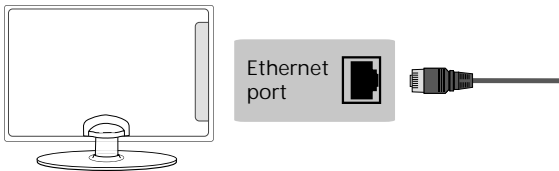

- 2) Press Menu on the remote control (fig.1).
- 3) Scroll through the menu, select and enter 'Settings' then enter the 'Network' menu.
- 4) In 'Network Configuration', select 'Cable' (fig.2).
- 5) Set will automatically configure itself.
- 6) Exit the menu by pressing 'EXIT' on the remote control.

fig.1



fig.2

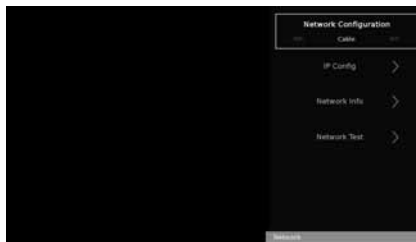

# PICTURE MENU

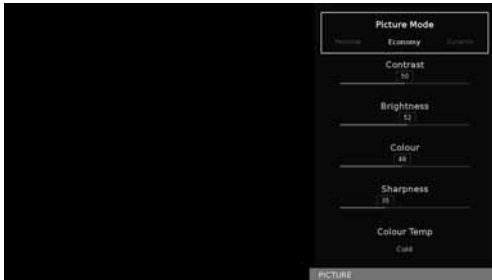

To access this menu, press [MENU] button on the remote control and scroll right.  
To select a sub menu press [OK].

If you wish to make changes to any of the default settings, use the scroll ▲▼▶◀ buttons.  
To confirm any settings press [OK] button. To exit this menu at anytime, press [EXIT] button.

Picture Mode - Choose from the following presets:

Dynamic	Recommended settings for fast moving pictures
Standard	Standard settings
Movie	Set to be lighter in colour and less bright
Personal	Lets you manually alter all the settings
Economy	Power saving mode which reduces the energy used by up to 25% (by reducing the power to the LED/LCD panel). In Economy mode, the TV will switch itself to Standby mode after 3-5 hours in the event that the TV buttons or remote control buttons are not pressed (change the picture mode to another setting to de-activate this function)

You can make the following adjustments in **Personal** mode:

**Contrast** - Switch the balance between black and white.

**Brightness** - Increase or decrease the brightness of the picture.

**Colour** - Increases the colour from black and white.

**Sharpness** - Increase or decrease the sharpness of the picture.

**Colour Temperature** - Choose from the following presets:

Normal	Default settings
Warm	Increases red within the picture
Cold	Increases blue within the picture



# PICTURE MENU



**Aspect Ratio** - Within the UK the picture format varies depending on the channel/broadcast. There are a number of different options to best meet your needs. Choose from the following settings:

## Auto

Automatically displays the best picture format so the picture is in the correct position, black lines maybe viewable at the top/bottom and/or sides.

## 4:3

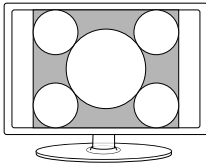

Displays the 4:3 picture in its original size. Side bars are shown to fill the 16:9 screen

## Full Screen

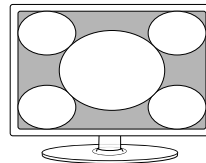

Displays a picture in the full screen size without overscan. 16:9 signal will be displayed in original proportion. Other picture format will be stretched to fill the screen

## 16:9

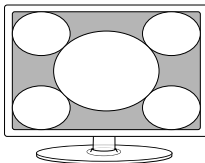

Fills the screen with a regular 16:9 signal and 4:3 picture format will be stretched to fill the screen

## Zoom1 and Zoom 2

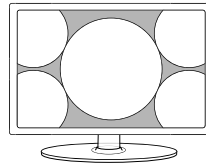

The picture is the correct proportion but zoomed in to fill the screen

**Noise Reduction** - Allows you to switch noise reduction ON or OFF. Choose one of the following presets: low, middle, high and Off.

**Active Contrast** - Automatically optimises the 'backlight' and 'contrast' of the picture according to the brightness of the screen. Choose one of the following presets: low, middle, high and Off.

# SOUND MENU

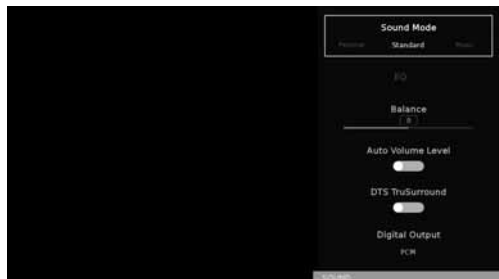

To access this menu, press [MENU] button on the remote control and scroll right.  
To select a sub menu press [OK].

If you wish to make changes to any of the default settings, use the scroll ▲▼▶◀ buttons.  
To confirm any settings press [OK] button. To exit this menu at anytime, press [EXIT] button.

Sound Mode - Choose from the following presets

Standard	Default settings
Music	Emphasises music over voices
Movie	Provides live and full sound for movies
Sports	Emphasises sound for sports
Personal	Selects your personal sound settings. Any adjustments made automatically sets the sound mode to Personal.

EQ - Adjust the audio level of separate frequencies via the band equaliser.

Balance - To switch the sound between the left and right speakers.

Auto Volume Level (AVL) - When 'on' is selected, the volume will attempt to stay at a constant level regardless of TV programme and advertisements.

DTS TruSurround - Choose from the following options:

Off	Off
TruSurround	TruSurround™ creates an immersive, feature-rich surround sound experience from two speakers, complete with rich bass, high frequency detail and clear dialog



For DTS patents, see <http://patents.dts.com>. Manufactured under license from DTS Licensing Limited. DTS, the Symbol, & DTS and the Symbol together are registered trademarks. DTS TruSurround is a trademark of DTS, Inc. © DTS, Inc. All Rights Reserved.

# SOUND MENU

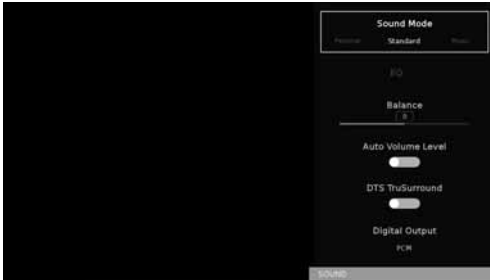

To access this menu, press [MENU] button on the remote control and scroll right.  
To select a sub menu press [OK].

If you wish to make changes to any of the default settings, use the scroll ▲▼▶◀ buttons.  
To confirm any settings press [OK] button. To exit this menu at anytime, press [EXIT] button.

Digital Output - This is the digital optical audio output. Choose from the following options:

Off	To turn off Digital Output
Auto	Selects the best settings automatically
PCM	Select this option if you are connecting to a Stereo Hi-fi via optical cable (Pulse-code modulation (PCM) is a digital representation of an analogue signal)

Audio Description - This allows the user to switch Audio Description ON or OFF. (Audio Description is a service available on certain programmes. It provides a description of what is happening during the selected programme for a person who is visually impaired).

AD Volume - This allows the user to increase and decrease the AD (Audio Description) volume level.

Audio Track - This allows the user to change the audio track/language

Audio Delay - Enables the user to adjust setting to sync picture and audio.

SPDIF Delay - Enables the user to adjust sound setting to sync picture and audio for external speakers connected via digital audio output.

**Tip:** Equaliser settings can only be adjusted when the sound mode 'Personal' is selected.

# CHANNEL MENU

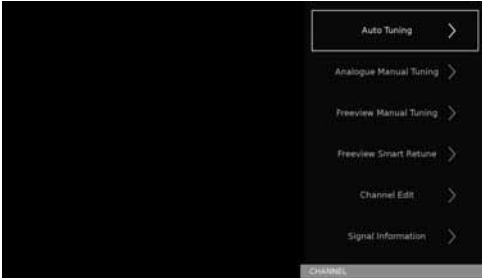

This menu is part of the 'Settings' menu, To access the 'Settings' menu, press the [MENU] button on the remote control, scroll right and select 'Settings' by pressing [OK].

If you wish to make changes to any of the default settings, use the scroll ▲▼▶◀ buttons. To confirm any settings press [OK] button. To exit this menu at anytime, press [EXIT] button.

Auto Tuning - Allows you to retune the television for all digital channels, digital radio stations and analogue devices.

Analogue Manual Tuning - Allows you to manually tune your analogue signal.

Freeview/Saorview Manual Tuning\* - Allows you to manually tune your digital signal.

Freeview SMART Retune - This feature allows you to scan for Freeview channels. When new channels are found they are automatically added to your channel list without removing any channels or affecting your favourites list.

Channel Edit - Allows you to delete, move, skip and select favourite channels.



Important: To receive Freeview/Saorview channels, in particular HD channels, you will need a Digital TV aerial and be in a good Freeview/Saorview coverage area. You can check the coverage for your area at [www.freeview.co.uk](http://www.freeview.co.uk) or [www.saorview.ie](http://www.saorview.ie)

Please note that any Freeview HD channels found during tuning will be placed in channel positions above 100. For example, 101 (BBC1 HD) 102 (BBC2 HD) etc.

**\*Freeview channels are only available in the UK, Saorview channels are only available in the ROI.**

Signal Information - Allows you to view signal frequency, signal quality and signal strength.

CI Information - Pay per view services require a "smartcard" to be inserted into the TV. If you subscribe to a pay per view service the provider will issue you with a 'CAM' and a "smartcard". The CAM can then be inserted into the COMMON INTERFACE PORT (CI Card In).

Schedule List - Lists your programme reminders.

Software Update (OAD) - Switch on/off OAD (over air download) software updates.

Tip: If you do not press any buttons for 30 seconds, the menu will automatically exit. You can change the length of time before the menu exits automatically - see 'OSD Timer' in the Time Menu

# NETWORK MENU



This menu is part of the 'Settings' menu, To access the 'Settings' menu, press the [MENU] button on the remote control, scroll right and select 'Settings' by pressing [OK].

If you wish to make changes to any of the default settings, use the scroll ▲▼▶◀ buttons. To confirm any settings press [OK] button. To exit this menu at anytime, press [EXIT] button.

The Network connection enables you to update the TV software and a number of Smart TV functions.

For the network configuration to work the TV will need to be connected to your home network via an ethernet cable, with these requirements in place the TV will connect to the network automatically.

Network Configuration - Allows you to select either Cable or Wifi connection.

WIFI / IP Config - Allows you to access LAN network connection settings. Choose from the following options:

Auto	Will automatically connect the TV to your home network(this is the default setting and is highly recommended)
Manual	Allows you to manually change the IP, Netmask, Gateway and DNS information.

WIFI Config - If WIFI is selected during first time installation process.

Wi-Fi Configuratrion	Wireless network connection settings
Wi-Fi Auto Search	Automatically searches for available wireless networks. Select the desired Wi-Fi network and then enter the network password (if network is password protected). Once the password is accepted, you will not be asked for it again.

Network Info - Allows you to view Information about network settings.

Network Test - Allows you to test the network connection.

Wifi Status - Allows you to view information regarding the Wifi/Network connection.

# TIME MENU

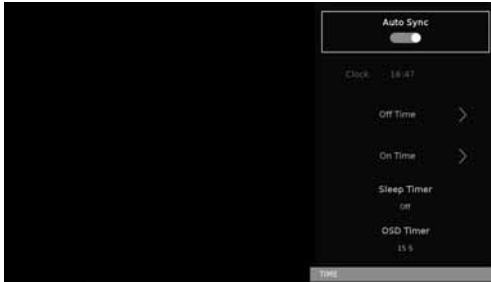

This menu is part of the 'Settings' menu, To access the 'Settings' menu, press the [MENU] button on the remote control, scroll right and select 'Settings' by pressing [OK].

If you wish to make changes to any of the default settings, use the scroll ▲▼▶◀ buttons. To confirm any settings press [OK] button. To exit this menu at anytime, press [EXIT] button.

---

Auto Sync - Automatically sets date and time.

Clock - Shows the date and time.

Off Time - Allows you to set a specific time for your TV to turn off.

On Time - Allows you to set a specific time for your TV to turn on, the channel it will then display, the source it will be on and also the volume. This function can then be toggled to repeat every day or a certain day.

Sleep Timer - Lets you set the sleep timer so the television automatically switches off after a set amount of time. Off -> 10min -> 20min -> 30min -> 60min -> 90min -> 120min -> 180min -> 240min.

OSD Timer - Lets you adjust the amount of time the On Screen Menu stays on the screen before disappearing. Off -> 5secs -> 15secs -> 30secs -> 60secs.

Auto standby - Set 'Auto Standby' to OFF, 3 hours, 4 hours or 5 hours.

Time Zone - Change your current time zone.

# LOCK MENU

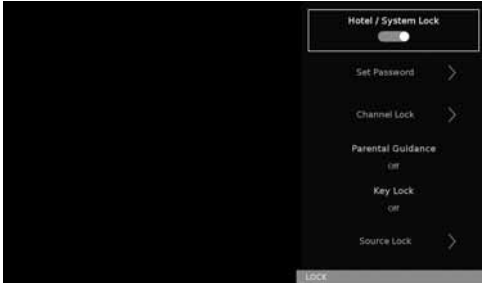

This menu is part of the 'Settings' menu. To access the 'Settings' menu, press the [MENU] button on the remote control, scroll right and select 'Settings' by pressing [OK].

If you wish to make changes to any of the default settings, use the scroll ▲▼▶◀ buttons. To confirm any settings press [OK] button. To exit this menu at anytime, press [EXIT] button.

- Hotel/System Lock - Allows you to lock or unlock the menu. You will be asked to enter a 4 digit password. Use the ◀ button to quit the password input or use the ▶ button to clear. Default password is 0000.
- Set Password - Allows you to change the password.
- Channel Lock - Allows you to lock certain channels manually.
- Parental Guidance - Allows you to set the rating to block certain content based on age information.
- Key Lock - Allows you to lock the buttons on the side of the TV set.
- Source Lock - Allows you to lock the source menu.
- Hotel Mode - Additional settings.

# SETUP MENU

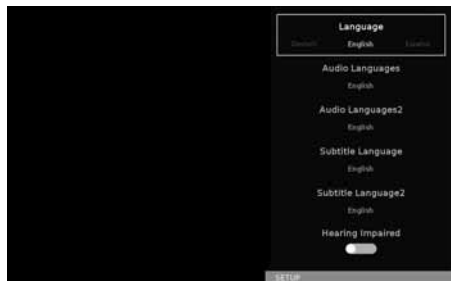

Language - Allows you to change the language of the menu.

Audio Language - Select your preferred primary audio language.

Audio Language 2 - Select your preferred secondary audio language.

Subtitle Language - Select your preferred primary subtitle language.

Subtitle Language 2 - Select your preferred secondary subtitle language.

Hearing Impaired - This allows the user to turn on the Hearing Impaired function, this produces subtitles on the screen which provide a description of what is happening during the selected program.

Blue Screen - Changes the background when there is no input between clear and a blue background (only available on some sources).

First Time Installation - Allows you to access the First Time Installation menu and retune the TV set.

Software Update (USB) - Allows you to update your TV with the newest software using a USB memory stick. Software and instructions are available on our website.

Software Update (NET) - Allows you to update your TV with the newest software via your internet connection.

Reset TV - This resets the menus to factory settings and clears all the TV channels from the television.

HDMI CEC (Consumer Electronic Control) - Allows HDMI devices to control each other and allows the user to operate multiple devices with one remote control (only available with compatible devices).

LED Status - LED Status - Allows the user to switch the LED power indicator light ON or OFF when the TV is being operated. (When this option is set to OFF the LED power indicator light will flash when the remote control is used and will flash red during the normal start up process).

Standby Scan - When the TV is put into standby mode a standby scan will be performed, during this process the TV will scan for new channel information and automatically update the channel list if any changes are found, both the visual and audio functions will be off, once the scan is complete the TV will stay in standby mode.

Version Info - Allows you to view the version/information of the software installed on the TV set.

**Note:** For further support with software updates, contact our technical support team or refer to the 'product support' section of the website. If the TV is using the newest software available it will not attempt to update the software.



## MORE APPS MENU

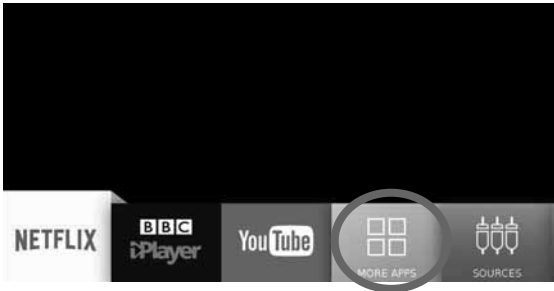

To access this menu, press [MENU] button on the remote control and scroll right.  
To select a sub menu press [OK].

If you wish to make changes to any of the default settings, use the scroll ▲▼▶◀ buttons.  
To confirm any settings press [OK] button.

To exit this menu at anytime, press the 'MENU', 'EXIT' or 'BACK' button on the remote control.

As well as the Netflix, BBC iPlayer and YouTube apps included in the main menu, the More Apps menu, located at the bottom of the screen, allows you to access more the TV set's "SMART" features such as Web Browser, BBC Sport, BBC News etc.

## Blaupunkt Smart Portal



Blaupunkt Smart Portal is a portal to a variety of apps and multimedia which the TV accesses via the internet. To enter the Blaupunkt Smart Portal you will be prompted to enter a language and accept the terms and conditions. Once the relevant information has been entered you will be able to use a range of features such as MUZU.TV, Viewster and Dailymotion. Content is updated and managed from a central source, so look out for new features and updates.

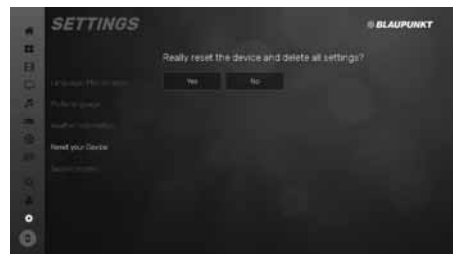
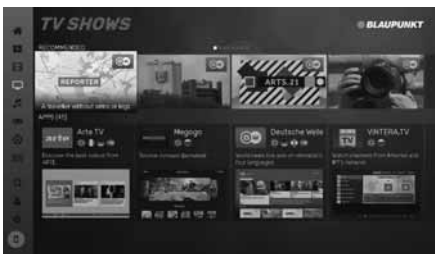

**Note:** If you wish to reset the settings for Blaupunkt Smart Portal back to the default settings, you will need to access the Blaupunkt Smart Portal and enter the settings menu. In the settings menu scroll down and select 'reset your device', you will then be asked 'Yes' or 'No' to confirm your decision, highlight 'Yes' and press 'OK' on the remote control to complete the reset process.

# MORE APPS MENU

## Applications



BBC iPlayer - Catch up on your favourite BBC TV programmes and view exclusive content.

BBC News - Access the BBC News app for up-to-the-minute and breaking news reports.

BBC Sport - The BBC Sport app offers the latest sports news, live action, scores and highlights.

Weather - keep track of the weather by using the weather forecasting app, AccuWeather.

Web Browser - Application for accessing websites via the internet. Use the following buttons for navigation in the browser:

CH+	Scroll page up
CH-	Scroll page down
Red Button	Show/hide browser menu bar
Yellow Button	Zoom in
Blue Button	Zoom out

**Note:** The Netflix and YouTube apps are included within the main menu for quicker access, they are not included in the "More Apps" menu.

# MEDIA MENU

## Miracast (screen mirroring)

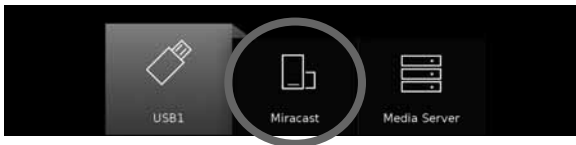

The Miracast (screen mirroring) feature allows you to connect to a compatible external device such as a tablet and/or smartphone. Once connected, your device will mirror all its content on to the TV, this allows you to view photos, emails and allows almost unlimited applications including many video on demand and subscription based services, for example Blinkbox, Netflix and Amazon, to be played on your smartphone or tablet and at the same time wirelessly 'streamed' and viewed on the TV.

Many Android and Windows devices include 'Screen Mirroring' as standard. Apple devices do not currently allow it, however, it is possible to 'mirror' from your Apple smart phone or iPad etc. when used with an Apple TV box (available separately).

**Note:** If your smartphone or tablet does not include 'Mirroring', it may be possible to connect a suitable cable from your device directly to one of the HDMI inputs on the rear of the TV (for example, if your device supports video output and has a Micro USB socket, you can purchase a Micro USB to HDMI cable from your retailer).

# MEDIA MENU

## USB mode and media server



The USB media and the media server offer the playback of various different types of content that is either saved on your USB memory stick or external media server. (USB mode allows you to view/playback files from an external USB device and Media Server connects to your home network and can view/playback files from your laptop, PC, tablets and smart phones).

When accessing the USB media or media server features the below menu screen will appear. The content will be divided into Photo, Music, Movie and All.



1) You can navigate through the menus using the scroll ▲▼▶◀ buttons on the remote control, to confirm the item you wish to play/view press the [OK] button.

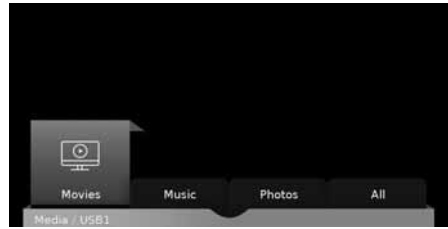

2) USB - Select the USB drive (If your drive only has 1 partition you will only see 1 item)  
Media server - Select the external device that you would like to access.

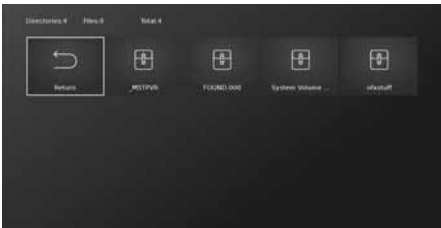

3) You can now access the item. Press OK to view.

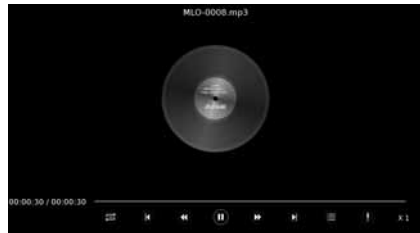

4) Whilst viewing your media, you can control the item by using the remote control buttons (below) or by pressing (Info) to access the on-screen playback menu, you can now make your selection by using the ▲▼▶◀ and (OK) buttons on the remote control.

Fig.A



**Tip:** If you experience a playback issue, please ensure the files being used are the correct format (example - the picture plays but no sound) See technical specification page for compatible file types

**Note:** USB extension cables are not recommended as they can cause a reduction in picture/audio quality and stoppages during play back of USB content.

# USB RECORD - FREEVIEW/SOARVIEW MODE

## USB RECORD – FREEVIEW/SAORVIEW MODE - FOR MODELS WITH THE PVR FUNCTION ONLY

Built into this television is a USB record facility. This function is available in Freeview/Soarview mode when used in conjunction with a compatible USB memory stick or USB hard drive. The benefits of this are as follows:

- Pause live TV and then playback, fast forward and rewind (up to live TV)
- One button record, if you decide you want to record the current programme
- Easy programmable recording from the 7 day TV Guide

Due to the nature of the product, it is necessary to use a high speed USB memory stick (as the TV reads from and writes to the memory stick at the same time, some memory sticks may not be suitable).

You can purchase high speed memory sticks from some computer stores, alternatively, we have a selection of tested and compatible memory sticks available to purchase directly from the helpline/web site.

### Recommended Minimum Specification - USB Memory Stick

Read Speed	20 Mb/s (MegaBit Per Second)
Write Speed	6 Mb/s (MegaBit Per Second)

If you wish to use a USB portable hard drive larger than 32GB, please refer to the FAQ section at the rear of this user guide.

## Pause Live TV (Time Shift)

Pausing Live TV is very simple.



- ⏸ - Press the play/pause button and the television will pause and the live content will be recorded. To resume watching press play/pause again.
- ⏩ - Press fast forward to go forward in a recording (i.e. to skip adverts).
- ⏮ - Press fast rewind to go back in a recording (i.e. if you fast forwarded too far).

**Tip:** When you switch the TV to standby or change channel the Time Shift memory is wiped. To restart time shift you must press play/pause button.

## One Button Record

At any point in time you may decide to record the current programme that you are watching. To do this you need to press the red button highlighted below.



## Playback files from Record list

To playback recorded files you will be required to have the TV set to the Freeview/Saorview source mode. Once set to the correct source, access the recorded list by pressing the REC LIST (Recorded List) button on the remote control, the recorded list should now appear on the screen, press OK on the chosen file to start.



**Tip:** This television contains one TV tuner, therefore it can only record the channel you are watching or record one channel while the television is in standby mode.

**Note:** USB record function is only available in Digital/Freeview TV mode. Due to copyright laws and illegal copying/recording it is not possible to record to/from any other input/output source.

# USING YOUR TV WITH A SKY DIGITAL SET TOP BOX

## Option 1) Connecting your TV to your Sky box (when both the TV and Sky Box are located in the same room)

Depending on your Sky Box & TV model, connect either by SCART or HDMI cables (available separately) .

If connecting by SCART, select the 'Input source' on the TV as SCART. If your TV does not have SCART, please refer to 'Connections' pages in this user guide for alternative ways to connect.

If connecting by HDMI, select the 'Input source' on the TV as HDMI (if the TV has more than 1 HDMI port, ensure you select the input source to match the HDMI numbered port on the rear of the TV).

If you wish to use your Sky remote to operate the TV's functions, you will need a Sky remote control (Revision 9 or later) and you will need to program a 4 digit code into it. See bottom of this page.

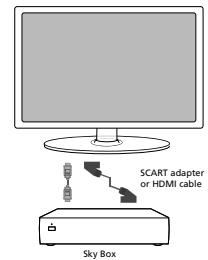

## Option 2) Connecting your TV to your Sky box (when your Sky box is located in a different room to the TV)

Please note, if you are adding a 'Magic Eye/TV Link' to your system so that you can use your Sky remote control to change the Sky channel in the room where the 2nd TV is located, please refer to the instructions included with the TV link/magic eye in order to ensure the RF or RF2 output on your Sky box is powered on. (The red LED light on the TV link/magic eye will light up) If you do not have the instructions that came with the TV link/magic eye, instructions on how to do it can be found on our web site.

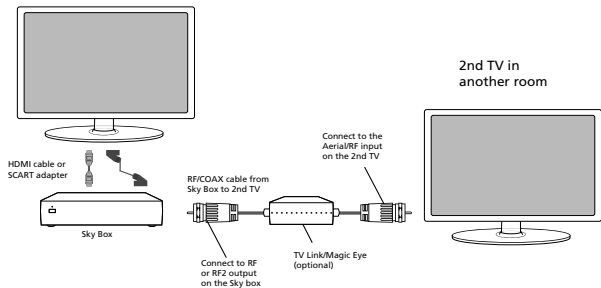

- 1) To tune the TV to the Sky box, on the 2nd TV, select the 'Analogue' input source.
- 2) Select the channel that you wish to store the Sky box/channel on. (If you do not use channels 1-5 because you no longer have analogue terrestrial channels after digital switchover, you may choose to select channel 1 to store the Sky box/channel, if you still have and use analogue channels 1-5, you may for example decide that channel 6 is the best option for you)
- 3) Press the corresponding number on the remote control to select the desired analogue channel chosen as per point 2 above.
- 4) On the TV remote control, press Menu. Now navigate through the menus to select Manual Tuning or Analogue Manual tuning (refer to the Tuning/Channel menu section of this user guide if necessary)
- 5) Manually tune in the channel (usually, the Sky box is at a frequency between 800Mhz and 850Mhz) once the Sky box/channel is found, press 'OK' to store it.

If you wish to use your Sky remote to operate the TV's functions, you will need a Sky remote control (Revision 9 or later) and you will need to programme a 4 digit code into it. See below.

### Using a Sky remote or a universal remote to operate your TV

**Sky remote control** - If you wish to use your Sky remote to operate the basic functions of your TV, you need to program a 4 digit code into it. Please note - you will need a Sky Revision 9 remote control (or later). **The code required for this television is 2134.** If you wish to upgrade/replace your existing Sky remote control to the latest version, you can do so on our website.

**Universal remote control** - If you wish to use a Universal remote control to operate your TV, please refer to the website for a full list of codes. (Please note we only have codes for One for All branded remote controls, if you have an alternative brand of Universal remote, please refer to the manufacturer for the code.)

# FREQUENTLY ASKED QUESTIONS

General	I would like to have louder sound by connecting additional speakers. For TV models with digital optical audio output.	<b>Option1)</b> Use the 3.5mm headphone output and a 3.5mm to phono cable (available separately) to connect to an amplifier/surround sound system. Please note this will deactivate the TV's built in speakers. <b>Option 2)</b> Connect a digital optical audio cable from the TV's digital optical audio output to your amplifier/surround systems digital optical audio input.
General	Why are some options in the menu unavailable and greyed out.	Some options are only available in certain sources, i.e. HDMI. They are unavailable in the other sources where they have no affect.
General	Can I stop my TV automatically turning off after 4hrs?	Yes, in the 'Time' menu settings, scroll down to Auto standby and select OFF.
General	Why does the led flash when I turn on my TV?	The LED will flash during the TV's boot up process. Once the TV is fully operational the LED light will stop flashing, indicating that the TV is fully functional and ready to use.
TV	I have tuned in Digital TV but I am not receiving any or all of the channels and/or the channels I receive are breaking up.	<b>1)</b> Check you are in an area that can receive Freeview/Saorview, visit <a href="http://www.freeview.co.uk">www.freeview.co.uk</a> or <a href="http://www.saorview.ie">www.saorview.ie</a> <b>2)</b> Check you are using an aerial that is able to receive a good digital signal. In most cases, you will need an outdoor digital hi-gain/wideband aerial. In areas that have excellent digital coverage, you may be able to use a loft type aerial but it is highly likely that you will also need to connect a booster between the back of the TV and the TV aerial wall socket. Unfortunately, to receive a good enough digital signal, it is not possible to use a portable/indoor type aerial.
TV	I have re-tuned my television but when I switch it off it is not storing the channels.	If the TV does not save the channels when you power it off, it's likely the channel database has become corrupt. <b>1)</b> Turn off the TV. <b>2)</b> Remove the RF/Aerial cable from the rear of the TV and then turn the TV back on again. <b>3)</b> Using the remote control, press Menu followed by 8-8-8-8 to enter the initial setup/first time installation menu. <b>4)</b> Press OK (let the TV run the full tuning process). <b>5)</b> Once completed, turn off the TV, reconnect the RF/Aerial cable then turn the TV back on again. <b>6)</b> Repeat steps 3 & 4.
VCR/DVD Recorder	I have connected the TV to my VCR or DVD Recorder via SCART but it is not recording.	In addition to connecting via SCART, you should connect the aerial cable from the wall socket to your VCR/DVD Recorder and another aerial cable from the VCR/DVD Recorder to the TV.
Game Consoles	I have connected my Playstation/ Xbox to the TV via HDMI, but I am not receiving any pictures or sound on my TV	<b>1)</b> Ensure the TV's source is set to HDMI. <b>2)</b> Check your settings on your Playstation/Xbox are as per the Playstation/Xbox instruction manual.
Game Consoles	I have connected my Playstation/ Xbox to the TV via Component cables (red, green & blue) but I am not receiving any sound.	Component cables only provide HD pictures. For the sound you will need to connect the red & white audio cables on the Playstation/Xbox to the red & white phono inputs (or mini AV input where fitted) on the rear of the TV. Please refer to the 'Connections' pages.
System Lock	I have changed the password on the television and now forgotten it.	There is a master password of 4711, to gain access to the TV menu and reset the normal password.
USB Mode	I have inserted a USB Memory Key, but the TV does not recognise it.	Ensure the USB Memory Key is formatted to type FAT32.
USB Mode	Using a USB portable hard drive / larger than 32GB.	If you wish to use a portable hard drive larger than 32GB, please note that it must be formatted to the FAT32 file system in order to operate on this TV. Windows XP/Vista computers are only capable of formatting up to 32GB, therefore, you will need a software programme/utility to format larger hard drives. Please refer to the website, <a href="http://www.umc-uk.co.uk">www.umc-uk.co.uk</a> , for more information.

# FREQUENTLY ASKED QUESTIONS

Freeview HD	I cannot access all Freeview channels.	Some data channels for Freeview can only be obtained when the TV's ethernet port is connected to your router.
Freeview HD	I cannot find the Freeview HD channels.	Freeview HD channels found during tuning will be placed in channel positions above 100. For example, 101 (BBC1 HD), 102 (BBC2 HD) etc.
Smart	I cannot access Smart apps on my Smart TV.	<p>Check your TV is connected to the internet and there is suitable signal strength. You can carry out a Network Test as follows:</p> <ol style="list-style-type: none"> <li>1) Press Menu on the remote control.</li> <li>2) Select 'Network' Menu then 'Network Test'.</li> <li>3) This will show the status of the internet connection.</li> </ol> <p>If you have no internet connection you must re-connect your TV as follows:</p> <ol style="list-style-type: none"> <li>1) Press Menu on the remote control.</li> <li>2) Select 'Network' Menu then 'Wi-fi config'.</li> <li>3) Then 'Wifi Auto Search'.</li> <li>4) The TV will then automatically search for Networks.</li> <li>5) Select the desired network then enter the Network password.</li> <li>6) The TV will then connect.</li> </ol> <p>Note: An icon will appear in the top right hand side of the Application page to show you if the TV is connected to the internet.</p>
Smart	I cannot access content through the Media Server settings	Check your TV is connected to your local network and there is suitable signal strength. Check the server devices you are trying to connect with are also on the Network and are set to share content.
Smart	I cannot access content through the Wireless Connection settings	Ensure the device you are trying to mirror onto the TV is correctly paired with the TV. Check the settings on the device, move your device closer to the TV set, check the user guide of the device to ensure it is compatible with this function.
Smart	While using Media Server, access is not possible or connection is slow	<p>If the folder you are attempting to view contains a large amount of files, it may take a little while to load, this is normal, content may be blocked on the host PC. Reconfigure the host PC to allow external access.</p> <p>Note: Host may not be connected to your network.</p>
Smart	I cannot access Facebook or Twitter	Ensure that you have an active account and that your network is not blocking access to these sites.
Smart	The YouTube app does not work and/or is erratic	The Youtube app requires the TV to be set with the correct date and time, please see the 'Time Menu' page for further instructions. Ensure your network is not blocking access to YouTube and the speed of your internet connection is fast enough for viewing YouTube content.

# TECHNICAL SPECIFICATION

## Product fiche

Trademark	Blaupunkt
Model ID	32/148M-GB-11B-EGPX-UK
Energy efficiency class	A+
Visible screen size (diagonal)	81 cm / 32 inches
On-mode power consumption	31.0 W
Annual energy consumption *1	45 kWh
Standby power consumption *2	<0.50 W
Off mode power consumption	0
Screen resolution	1366 (H) x 768 (V)
*1: Energy consumption XYZ kWh per year, based on the power consumption of the television operating 4 hours per day for 365 days. The actual energy consumption will depend on how the television is used.	
*2: When the TV is turned off with the remote control/standby button and no function is active.	

## Additional technical information

RF	75 ohm Antenna / Analog / DVB
Inputs	3 x HDMI, 2 x USB, 1 x Mini-SCART, 1 x RJ45 LAN/Ethernet, 1 x Mini Component/YPbPr, 1 x Mini AV IN - Composite Video/CVBS and L/R Audio shared for Composite Video and Component/YPbPr
Sound Outputs	1 x Digital Optical Audio output, 1 x 3.5mm Headphone
Speaker / Amplifier Watts (RMS)	2 x 10 / 2 x 8
Voltage and power consumption	220-240V 50Hz 31/45/70 W (ecomode/standard/max)
Dimensions including stand (mm)	739 W x 493 H x 180 D
Net weight (Kgs)	4.8
Wall Mounting	VESA 200 x 100 (mm)



# TECHNICAL SPECIFICATION

## Product fiche

Trademark	Blaupunkt
Model ID	40/148M-GB-11B-FEGPX-UK
Energy efficiency class	A+
Visible screen size (diagonal)	102 cm / 40 inches
On-mode power consumption	48.0 W
Annual energy consumption *1	70 kWh
Standby power consumption *2	<0.50 W
Off mode power consumption	0
Screen resolution	1920 (H) x 1080 (V)
<p>*1: Energy consumption XYZ kWh per year, based on the power consumption of the television operating 4 hours per day for 365 days. The actual energy consumption will depend on how the television is used.</p> <p>*2: When the TV is turned off with the remote control/standby button and no function is active.</p>	

## Additional technical information

RF	75 ohm Antenna / Analog / DVB
Inputs	3 x HDMI, 2 x USB, 1 x Mini-SCART, 1 x RJ45 LAN/Ethernet, 1 x Mini Component/YPbPr, 1 x Mini AV IN - Composite Video/CVBS and L/R Audio shared for Composite Video and Component/YPbPr
Sound Outputs	1 x Digital Optical Audio output, 1 x 3.5mm Headphone
Speaker / Amplifier Watts (RMS)	2 x 10 / 2 x 8
Voltage and power consumption	220-240V 50Hz 48/75/90 W (ecomode/standard/max)
Dimensions including stand (mm)	929 W x 603 H x 217 D
Net weight (Kgs)	8.1
Wall Mounting	VESA 200 x 200 (mm)

# TECHNICAL SPECIFICATION

## Compatible file types for USB and DLNA

Media	Codec	Resolution	Bit Rate	File Extension
Film	MPEG1/2	1080P@60fps	40Mbps	.DAT, .VOB, .MPG, .MPEG, .ts, .trp, .tp, .mp4, .mov, .3gpp, .3gp, .avi, .mkv, .asf
	MPEG4	1080P@60fps	40Mbps	.MPG, .MPEG, .mp4, .mov, .3gpp, .3gp, .avi, .mkv, .asf
	XviD	1080P@60fps	40Mbps	.mp4, .mov, .avi, .mkv, .asf
	Sorenson H.263	1080P@60fps	40Mbps	.flv
	H.263	1080P@60fps	40Mbps	.3gpp, .3gp
	H.264	1080P@60fps	80Mbps	.flv, .mp4, .mov, .3gpp, .3gp, .ts, .trp, .tp, .avi, .mkv
	HEVC/H.265	2048x1088@60fps	30Mbps	.mp4, .mkv
	AVS	1080P@60fps	40Mbps	.ts, .trp, .tp
	AVS+	1080P@60fps	50Mbps	.ts, .trp, .tp
	VC1	1080P@60fps	40Mbps	.wmv
	Motion JPEG	640x480@30fps	10Mbps	.mov, .avi, .mkv
VP8	1080P@30fps	20Mbps	.mkv, .webm	
VP9	2048x1088@60fps	30Mbps	.mkv, .webm	
Media	Codec	Frequency	Bit Rate	File Extension
Music	MPEG1/2 Layer1, 2, 3	16KHz ~ 48KHz	Layer1 32Kbps ~ 448Kbps Layer2 8Kbps ~ 384Kbps Layer3 8Kbps ~ 320Kbps	.avi, .asf, .mkv, .ts, .trp, .tp, .DAT, .VOB, .MPG, .MPEG, .mp3, .wav, (Layer3 - .3gpp, .3gp, .flv, .swf, .m4a)
	AC3	32KHz, 44.1KHz, 48KHz	32Kbps ~ 640Kbps	.ac3, .avi, .mkv, .3gpp, .3gp, .mp4, .mov, .m4a, .ts, .trp, .tp, .DAT, .VOB, .MPG, .MPEG
	EAC3	32KHz, 44.1KHz, 48KHz	32Kbps ~ 640Mbps	.ec3, .3gpp, .3gp, .mp4, .mov, .m4a, .ts, .trp, .tp, .DAT, .VOB, .MPG, .MPEG
	HEAAC	8KHz ~ 48KHz		.aac, .avi, .mkv, .3gpp, .3gp, .mp4, .mov, .m4a, .ts, .trp, .tp, .flv, .rmvb
	VORBIS	Up to 48KHz		.mkv, .webm, .3gpp, .3gp, .mp4, .mov, .m4a, .ogg
	LPCM	8KHz ~ 48KHz	64Kbps ~ 1.5Mbps	.avi, .mkv, .3gpp, .3gp, .mp4, .mov, .ts, .trp, .tp, .DAT, .VOB, .MPG, .MPEG, .wav, .m4a
	LBR(cook)	8KHz, 11.025KHz, 22.05KHz, 44.1KHz	64Kbps ~ 128Kbps	.rm, .rmvb
	FLAC	8KHz ~ 96KHz	< 1.6Mbps	.mkv, .flac
	DRA	8KHz ~ 48KHz	< 512Kbps	.ts, .trp
Media	File Type	Resolution		File Extension
Photo	JPEG	15360x8640, (1920x8 x 1080x8)	Base-line	.jpg/.jpeg
		1024x768	Progressive	
	PNG	9600x6400	Non-interlace	.png
		1200x800	Interlace	
	BMP	9600x6400		.bmp
GIF	6400x4800 (800x8 x 600x8)		.gif	
Internal Subtitle	File Extension	Container	Subtitle Codec	
	mp4	MP4	DVD Subtitle, UTF-8 Plain Text	
	mkv	MKV	ASS, SSA, UTF-8 Plain Text, VobSub, DVD Subtitle	
	avi	AVI(1.0, 2.0)	XSUB, XSUB+	
External Subtitle	File Extension	Subtitle Parser	Remark	
	.srt	SubRip		
	.ssa/.ass	SubStation Alpha		
	.smi	SAMI		
	.sub	SubViewer, MicroDVD, DVDSubtitleSystem, Subldx(VobSub)	SubViewer 1.0 & 2.0 Only	
	.txt	TMPlayer		

 **BLAUPUNKT**

*Enjoy it.*



BLA/MAN/0373