

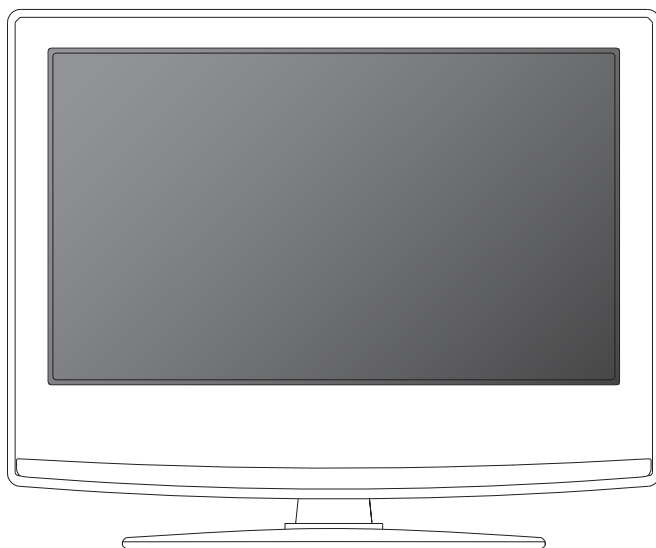

User Guide



Contents

Manufacturers guarantee information	3
Important safety instructions	6-7
Initial setup	8
TV buttons	8
Input Source menu	8
Remote control	9
Connections	10-14
TV operation	15-18
TV menu navigation	15
Channel menu	15
Picture menu	15
Sound menu	16
Time menu	16
System/Hotel lock menu	16
Setup menu	16
DVD setup	17
7 day guide and channel list	17
USB mode/media player	17
USB Record - Digital mode	18
3D settings	18
PC settings	19
Using your TV with a Sky digital set top box	19
Network configuration	20
Frequently asked questions	21-22

Important safety instructions



Please read these instructions. All the safety and operating instructions should be read before the appliance is operated.

Warnings

- Television sets which weigh 20kg or more must be lifted and carried by at least 2 people.
- This television does not contain any parts that are serviceable by the user. In case of a fault, contact the manufacturer or authorised service department. Exposing the internal parts inside the TV may endanger your life. The manufacturers guarantee does not extend to faults caused by repairs carried out by unauthorised third parties.
- To reduce the risk of fire, electric shock or damage to the TV, do not expose it to dust, rain or moisture. Never expose the TV to dripping or splashing and do not place objects filled with liquids on or near the TV.
- Do not connect any external devices (DVD player, games console etc) when the TV is switched on. Disconnect both the TV and device from the mains before connecting. Only switch appliances on when the connection process is complete.
- Do not place the television in a confined space and do not obstruct the ventilation openings at the rear of the television.
- When installing on a wall, ensure the TV is at least 5cm from the wall for ventilation.
- Dispose of this television and any components including batteries in an environmentally friendly manner. If in doubt, please contact your local authority for details of recycling.

Safety

- For your safety, this appliance is fitted with a fused 3 pin mains plug. Should the fuse need to be replaced, ensure that any replacement is of the same amperage and approved with the BSI mark.
- Never try and replace the mains plug unless you have adequate qualifications and are legally authorised to do so. In the event that a replacement mains cable is required, contact the manufacturer for a suitable replacement.
- Never use the television if it is damaged in any way.
- Always place the television on a flat level surface avoiding anywhere which may be subject to strong vibration.
- The ideal distance to watch the television is approximately five times the length of the diagonal measurements of the TV screen.
- Ensure the television is not placed on top of the power cable as the weight of the television may damage the cable and cause a safety hazard.
- Never place mobile phones, speakers or any other device which may cause magnetic or radio interference, near the television. If interference is apparent, move the device causing the interference away from the television.
- To isolate the TV from the mains power, please use the power switch located on the side, underside or rear of the TV set.
- Ensure that the power switch on the unit and the mains plug are always easily accessible.

WARNING: Excessive noise when using earphones and headphones can cause loss of hearing.

Maintenance

- To clean your TV wipe with a soft, dry cloth. If the surfaces are extremely dirty, use a soft cloth dipped in a soap and water solution or a weak detergent solution.
- Never use alcohol, paint thinner or benzene to clean this unit.
- Before using a chemically treated cloth, read the instructions that came with the cloth carefully.

CAUTION: If water or other liquid enters the television through the display panel surface, a malfunction may occur.

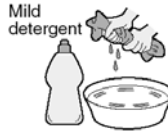

Packaging

- The safest way to transport your item is in the original box/packaging - please save your packaging for this.
- You will need the original box/packaging in the event of warranty/service repair or support. We are unable to carry out warranty/service if you are unable to package the item correctly.

Important information regarding use of video games, computers, captions or other fixed image displays

The extended use of fixed image program material can cause a permanent "shadow image" on the LCD/LED panel, also known as a "screen burn".

This "shadow image" can appear in the background during normal viewing. This type of irreversible LCD/LED panel deterioration can be limited by observing the following steps:

1. Reduce the brightness/contrast setting to a minimum suitable viewing level.
2. Do not display the fixed image for extended periods of time.
3. Turn the power off when not in use.

Examples of images that are more likely to cause "screen burn" are as follows (this is not an exhaustive list):

- TV channel logos: e.g. shopping channel logos and pricing displays - especially if they are bright and stationary. Moving or low-contrast graphics are less likely to cause ageing of the screen.
- Time displays.
- Teletext: Do not view a stationary page for a long period of time
- TV/DVD menus: e.g. listings of DVD disc content.
- Pause mode: Do not leave the TV in pause mode for long periods of time, e.g. when watching DVDs or videos.

Important: Once 'shadow image/screen burn' occurs, it will never disappear and is not repairable under warranty.

How do I dispose of this product?

UK: Waste electrical products should not be disposed of with household waste. Please dispose of the product at a designated collection point for recycling of WEEE. For your nearest facilities, please see www.recycle-more.co.uk or in store for details.



ROI: Waste electrical products should not be disposed of with household waste. Separate disposal facilities exist. Check with your local authority or retailer for recycling advice.

Batteries

- Do not expose batteries to high temperatures, excessive heat, prolonged sunshine or fire as this may cause leakage, explosion or ignition. Observe the correct polarity when inserting batteries.
- Do not use different types of batteries together or mix old and new batteries.
- Dispose of batteries in an environmentally friendly way.
- Certain regions may regulate the disposal of batteries. Please consult your local authority.



3D safety information

- If you watch the 3D imaging too closely or for a long period of time, it may harm your eyesight.
- Watching the TV or playing video games that incorporate 3D imaging with the 3D glasses for a long period of time can cause drowsiness, headaches or fatigue to you and/or your eyes. If you have a headache, feel fatigued or drowsy, stop watching the TV and take a rest.
- Pregnant woman, seniors, persons with heart problems or persons who experience frequent drowsiness should refrain from watching 3D TV.
- Please prevent children under the age of 5 from watching 3D TV as it may harm their vision development.

Warning for photosensitization seizure

- Some viewers may experience a seizure or epilepsy when exposed to certain factors including flashing lights or images in TV or video games. If you or anybody from your family has a history of epilepsy or seizure, please consult with your doctor before watching 3D TV.
- Certain symptoms can occur in unspecified conditions without any previous history.
- If you experience any of the following symptoms, immediately stop watching the 3D content and consult a doctor: dizziness or light headedness, altered vision, visual or facial instability, such as eye or muscle twitching, convulsion, loss of consciousness, confusion or disorientation, loss of directional sense, cramps, or nausea.
- Parents should monitor their children, including teenagers, for these symptoms as they may be more sensitive to the effects of watching 3D TV.

Risk of photosensitization seizure can be reduced with the following actions.

- Take frequent breaks from watching 3D TV.
- For those who have vision that is different in each eye, they should watch the TV after taking vision correction measures.
- Watch the TV so that your eyes are on the same level as the 3D screen and refrain from sitting too closely to the TV.
- Do not watch the 3D imaging when tired or sick and avoid watching the 3D imaging for a long period of time.
- Do not wear the 3D glasses for any other purpose than viewing 3D content on a 3D TV.
- Some viewers may feel disorientated after watching 3D TV. Therefore, after you watch 3D TV, take a moment to regain awareness of your situation before moving.

Securing the TV to a wall

For maximum security in the home, when using a TV with its stand, anti-tip straps should be fitted. These are available from supermarket websites and other websites and are an easy, inexpensive and effective way of ensuring your TV stays safely upright. Straps are designed to be attached to the rear of the TV and then tethered to the wall or the furniture the TV is stood on, these are fitted as follows:

1. Using one, or both, of the top wall-mounting holes and screws fasten one end of the fastening cord/s to the TV. (The screws are already supplied in the wall mounting holes).
2. Secure the other end of the fastening cord/s to your wall. (you will need screws/fixings suitable for your wall type - available separately from most DIY stores).

The Royal Society for the Prevention of Accidents is urging people to take care with flat-screen televisions.

RoSPA stated in 2010 that "Toddlers are particularly at risk of pulling flat-screen televisions on to themselves. They are unsteady on their feet and are attracted by colourful television images." The risk is increased as televisions become lighter.

Note: Please ensure that children do not climb on the TV set.

Initial setup

What's included in the box

- 1 x TV
- 1 x Remote control
- 2 x AAA batteries
- 1 x User guide
- 1 x Stand installation pack
- 1 x RF cable (selected models only)
- 1 x Quick start guide
- 3D Glasses (only included with TV models with 3D function)

Attaching the stand

Please follow the instructions in the 'Quick start guide' included with the TV set.

Setting up the TV

1) Using the RF cable supplied, connect the TV to the TV aerial wall socket and connect the power cable to the electrical outlet.

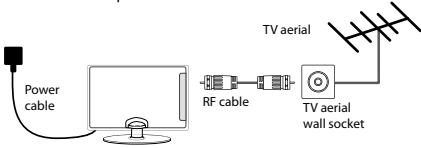

2) Switch on the television using the power on/off switch located on the side, underside or rear of the TV set.



3) Insert the batteries supplied into the remote control and press the standby button to power on the TV.



4) You will now be welcomed with the initial set-up screen. If it does not appear, press [MENU] then 8-8-8-8 and the menu will appear. Press OK on the remote control and tuning will start.

5) If you are missing channels, the reason for this is likely to be signal strength, you should consider connecting a signal booster and re-tuning the TV.

Please refer to the 'Quick start guide' for more details.

Resetting and retuning the TV

In the event that you need to reset the TV to the factory default settings or retune the TV, on the remote control press 'Menu' then 8-8-8-8. Press OK to retune.

Sky remote control information

If you wish to use your Sky remote to operate the TV's functions, you will need a Sky remote control (Revision 9 or later) and you will need to program it with the code **2134**.

For further information please refer to the user guide section 'Using your TV with a Sky Digital set top box'.



TV buttons

TV buttons are located on the side, underside, rear or top of the TV set.

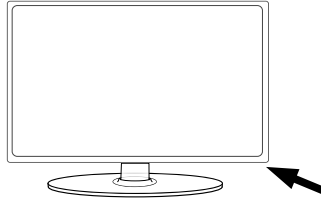

VOL +	Volume up and menu right
VOL -	Volume down and menu left
CH+	Programme/channel up and menu up
CH-	Programme/channel down and menu down
MENU	Displays the input source menu
SOURCE	Displays menu/OSD
STANDBY	Standby power On/Off
Additional buttons for DVD models only	
	Stop/eject Disc
	Play/pause Disc

Input Source menu

To switch between the different input/connections.

A) Using the buttons on the remote control:

1. Press [SOURCE] - The source menu will appear.
2. Press [V] or [^] to select the input you require.
3. Press [OK].

B) Using the buttons on the TV:

1. Press [SOURCE].
2. Scroll up / down using CH+ / CH- buttons to the input/source you require.
3. Press Vol+ to change input/source to the one selected.





For further information on input/connections please refer to the 'Connections' section in this user guide.



An example of the 'Input Source' menu (will vary by model)

Remote control

Key

-  For models with integrated DVD players
-  For models with PVR Function
-  For models with USB Playback
-  For models with 3D functions

1

- STANDBY** - Switch on TV when in standby or vice versa
- MUTE** - Mute the sound or vice versa
- DTV** - Switch to digital source
- RADIO** - Switch to radio whilst in digital TV source
- USB** - Switch to USB source
-  **DVD** - Switch to DVD source















2

- NUMBER BUTTONS** - 0 - 9 to select a TV channel directly.
- TV GUIDE** - Opens the 7 day TV guide (digital TV mode)
-  - To return to the previous channel viewed

3

- VOL (+/-)** - To increase/decrease the sound level
- P.MODE** - Scrolls through picture mode options
- S.MODE** - Scrolls through sound mode options
- FAV** - To display favourites menu
- CH (+/-)** - To increase or decrease the channel being watched
- MENU** - To display OSD menu
- EXIT** - To exit all menus
-  **OK** - Allows you to navigate the on-screen menus and adjust the system settings to your preference
- SOURCE** - To display the input/source menu
- INFO** - Press once for now/next channel information
- Press twice for information about the current programme

4

- ASPECT** - To switch the screen between the different picture formats
- SLEEP** - Press repeatedly to cycle through the sleep options
- AUDIO** - To change the audio language (if available)
- SUBTITLE** - To switch the dialogue at the bottom of the screen (on/off)
- TEXT** - To enter/exit Teletext (Analogue TV)
- TEXT HOLD** - Teletext mode - Holds current page which is displayed (Analogue TV)
- DISPLAY** - To switch off the screen when listening to radio
-  **TEXT/DVD ZOOM** - Zoom function for Teletext and DVD
-  **DVD MENU/RECORD** - Access the DVD menu and USB record function
 -  To restart the current chapter
 -  To advance forward to the next chapter
 -  To stop the playback/Eject Disc
(To EJECT the disc press/hold the  button for 4 seconds)
 -  To play in fast rewind mode
 -  To play in fast forward mode
 -  To play/pause
-  **DVD SETUP/REC LIST** - Opens up DVD menu or opens the list of what has been previously recorded
-  **GOTO** - To go to a specific chapter
-  **A-B** - Press once to set point, press a second time to return to point
 -  **ANGLE** - Select different angle of DVD
 -  **3D** - Switches between 3D settings
-  **REPEAT** - To repeat playback

1



2



3



4



Connections

Note: The TV input/output connections and connecting cables on these pages are shown for reference. Cables are available separately from your retailer. Not all connections are available on all TV models.

Connecting to a device with Composite AV/Video output

TV source should be set to Composite/AV

Connection example for TV models with Mini-AV in input

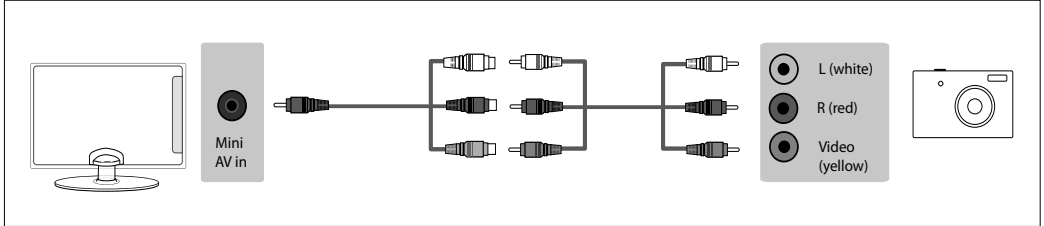

Connection example for TV models with L/R Audio and Video inputs

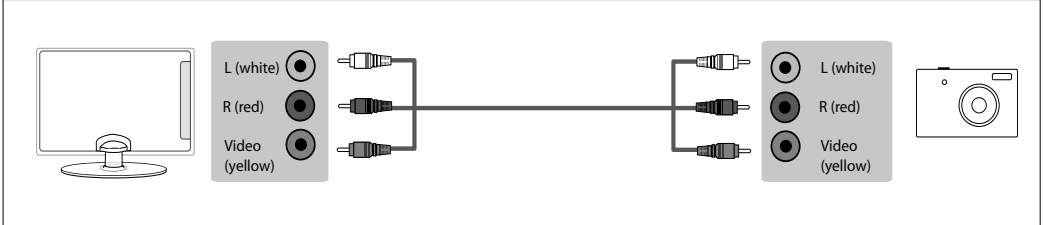

Connecting to a device with SCART output

TV source should be set to SCART

Connection example for TV models with SCART input



Connection examples for TV models with Mini-AV in input (1)

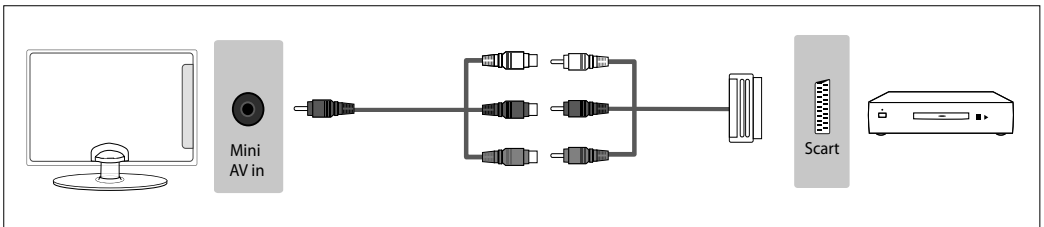

Connections

Connection examples for TV models with Mini-AV in input (2)

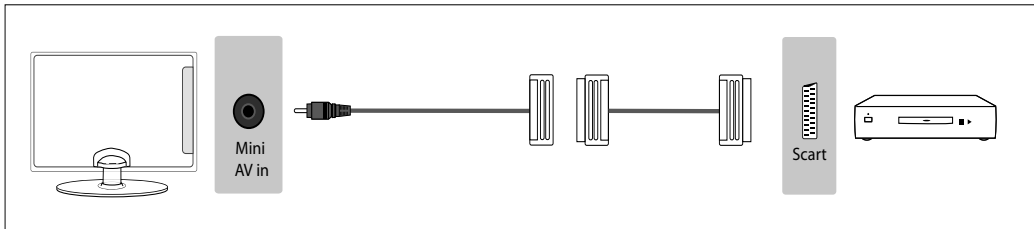

Connection example below for TV models with L/R Audio and Video inputs

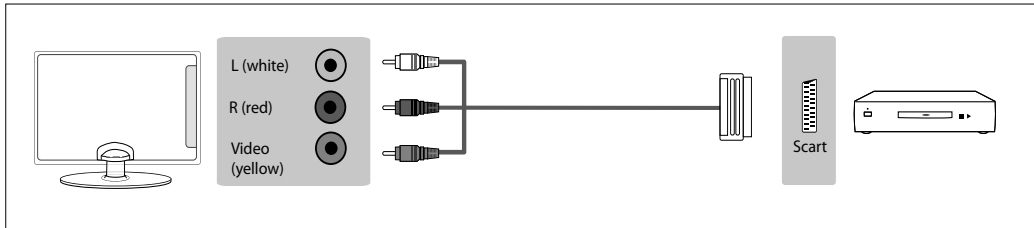

Connecting to a device with Component/YPbPr output

If you are supplied with a cable from the device which has RED, GREEN, BLUE, RED & WHITE connectors you must connect via Component (for picture) and by phono cable (for sound). TV source should be set to Component/YPbPr

Connection example for TV models with Mini-YPbPr and Mini-AV inputs

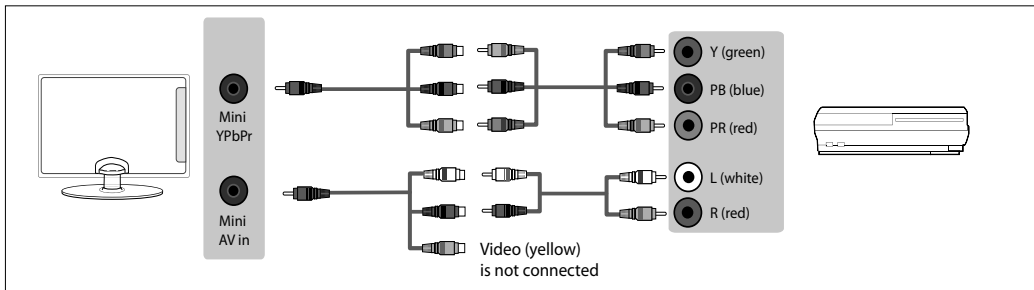

Connection example for TV models with Mini-YPbPr and L/R audio inputs

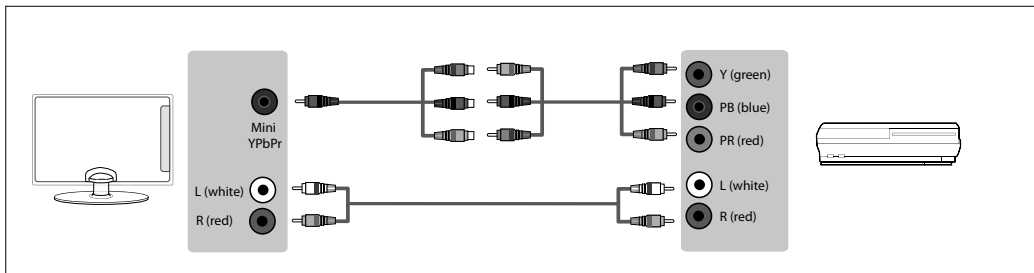

Connections

Connection example for TV models with YPbPr and L/R Audio inputs

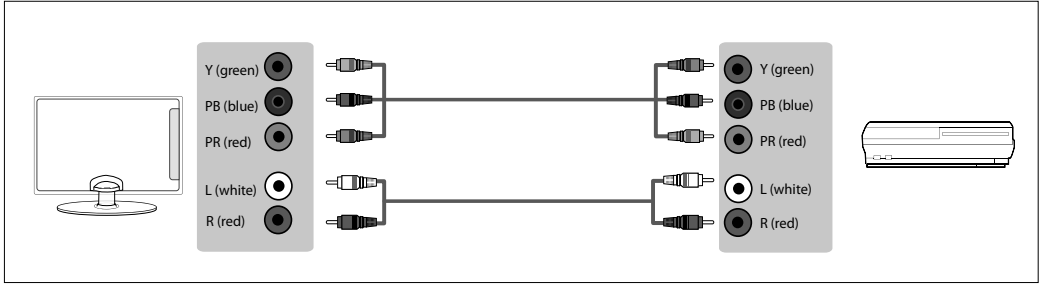

Connection example for TV models with YPbPr and Mini-AV inputs

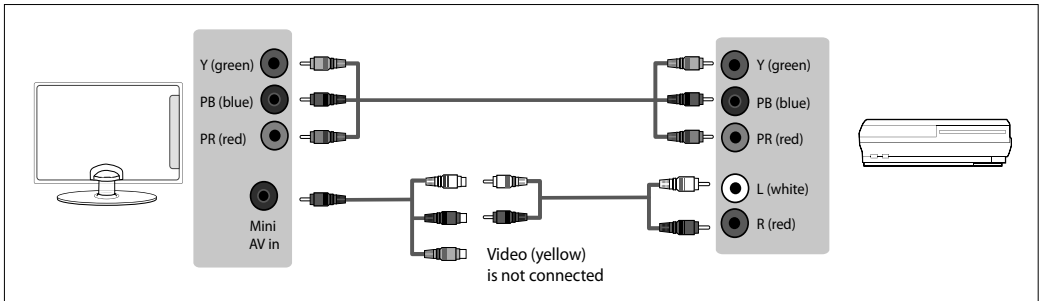

Connecting to an external audio device (Amplifier, Surround Sound, Sound Bars etc)

When connecting via the TV's 3.5mm earphone output, this will disable the TV speakers.

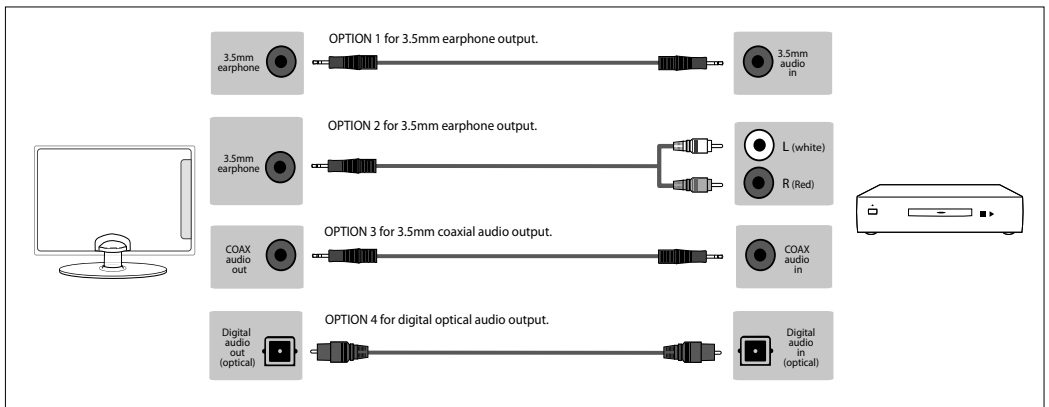

Connections

Connecting to a device with HDMI output

A HDMI cable can output both video and audio and enables you to enjoy digital-quality video and audio with minimal loss of quality. TV source should be set to the corresponding HDMI port (HDMI 1, HDMI 2 etc)

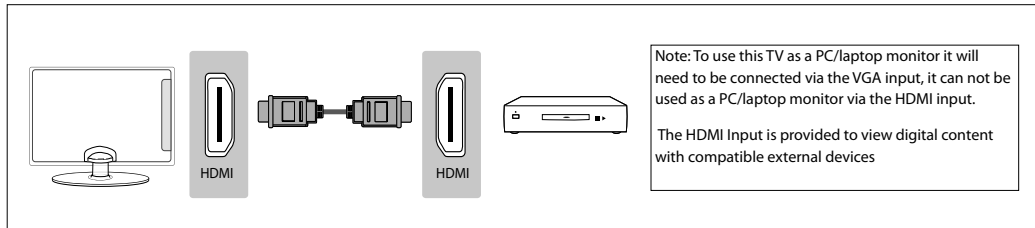

Connecting to a device with VGA/PC output (Laptop or Desktop Computer)

TV source should be set to VGA/PC

Depending on the PC/Laptop connected, you may need to configure your PC graphics card/adaptor to suit the screen resolution/Hz.

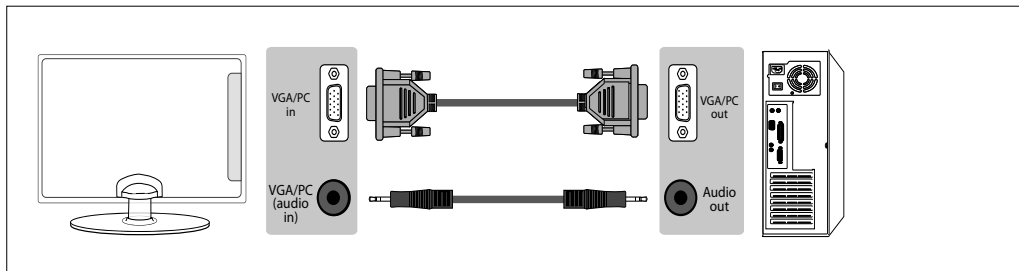

Connecting to a device with RF output (VCR, CCTV or other Analogue devices)

TV source should be set to ATV/Analogue TV.

Note: You will need to manually tune your device into an analogue channel.

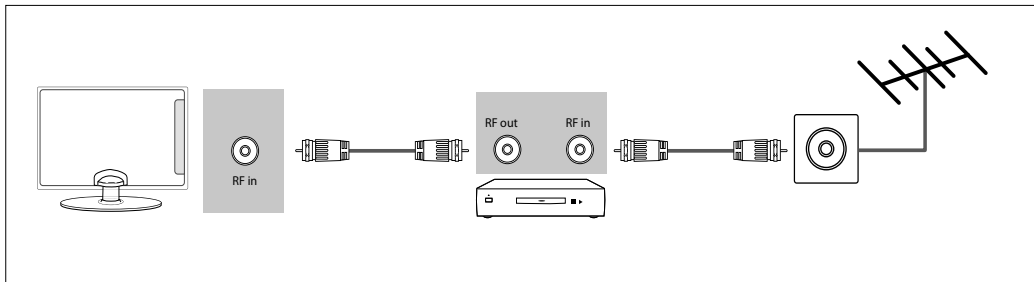

Connections

Connecting an Ethernet/Network cable

The Ethernet port is used only for Pay TV services and Freeview HD (Freeview services are only available in the UK). It is not intended to be used for internet/network use.

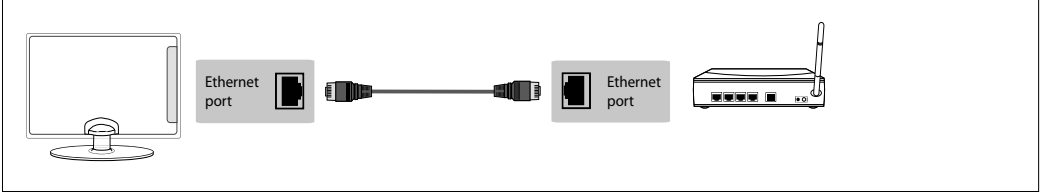

Connecting to a USB device

Many devices may need to be connected to the mains to power the device. Tablets and/or phones can be charged via the USB port but cannot be used to playback media content. TV source should be set to USB Media.

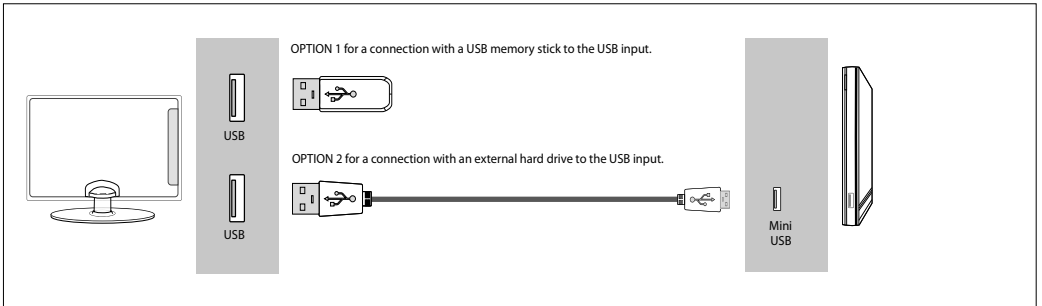

Connecting the TV to Earphones

When connecting via the TV's 3.5mm earphone output, this will disable the TV speakers.

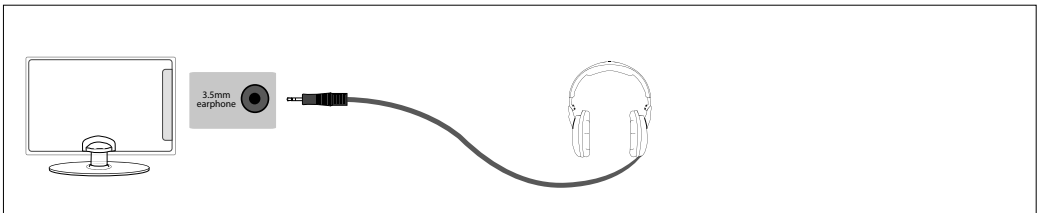

TV menu navigation

To access this menu, press [MENU] button on the remote control. To enter a menu press [OK]. If you wish to make changes to any of the default settings, use the scroll ▲▼▶◀ buttons. To confirm any settings press [OK] button. To exit this menu at anytime, press [EXIT] button.

Channel menu

Auto Tuning - Allows you to retune the television for all digital channels, digital radio stations and analogue channels.

Analogue Manual Tuning - Allows you to manually tune your analogue signal.

Digital Manual Tuning - Allows you to manually tune your digital signal.

Channel Edit - Allows you to delete, move, skip and add favourite channels.

Schedule List - Lists your programme reminders.

Signal Information - Allows you to view signal frequency, signal quality and signal strength.

CI Information - Pay per view services require a "smartcard" to be inserted into the TV. If you subscribe to a pay per view service, the provider will issue you with a "CAM" and a "smartcard". The CAM can then be inserted into the COMMON INTERFACE PORT (CI Card In).

Software Update (OAD) - Switch on/off OAD updates.

Picture menu

Picture Mode - Choose from the following presets:

Dynamic	Recommended settings for fast moving pictures.
Standard	Standard settings.
Mild	Set to be lighter in colour and less bright.
Personal	Lets you manually alter all the settings.
Economy	Power saving mode which reduces the energy used by up to 25% (by reducing the power to the LED/LCD panel). In 'Economy' mode, the TV will switch itself to standby mode after 3-5 hours in the event that the TV buttons or remote control buttons are not pressed. Change the picture mode to another setting to de-activate this function.

You can make the following adjustments in 'Personal' mode:

Contrast - Switch the balance between black and white.

Brightness - Increase or decrease the brightness of the picture.

Colour - Increases the colour from black and white.

Tint - Lets you increase or decrease the level of tint within the picture (only available in VGA/PC source mode).

Sharpness - Increase or decrease the sharpness of the picture.

Colour Temperature - Choose from the following presets:

Normal	Default settings
Warm	Increases red within the picture
Cold	Increases blue within the picture

Noise Reduction - Choose from the following presets:

Off	Turns noise reduction off
Low	Minor system adjustment
Middle	Medium system adjustment
High	Maximum system adjustment

Aspect Ratio - Within the UK, the picture format varies depending on the channel/broadcast. There are a number of different options to maximise your viewing experience.

Auto/Point 2 Point - Automatically displays the best picture format so the picture is in the correct position. Black lines may be viewable at the top/bottom and/or sides.

Original - Will display the picture from the broadcaster without any change.

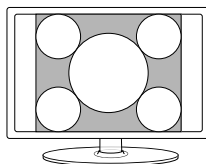

4:3 - Displays the 4:3 picture in its original size. Side bars are shown to fill the 16:9 wide screen.

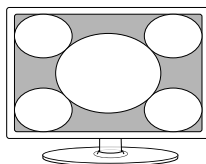

16:9 - Fills the screen with a regular 16:9 format. The 4:3 picture format will be stretched to fill the screen.

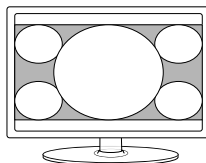

14:9 - Displays the 14:9 picture in the correct proportion. As a result bars are shown at the top/bottom of the screen.

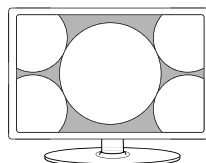

Zoom / Zoom 1 / Zoom 2 - The picture is the correct proportion but zoomed in to fill the screen. (Zoom 1 and zoom 2 is only available on TV models with built-in Freeview/Saorview HD)

Sound menu

Sound Mode - Choose from the following presets.

Standard	Default settings
Music	Emphasises music over voices
Movie	Provides live and full sound for movies
Sports	Emphasises sound for sports
Personal	Selects your personal sound settings

Treble - To adjust the amount of high frequency within the sound.

Bass - To adjust the amount of low frequency within the sound.

Balance - To switch the sound between the left and right speakers.

Auto Volume Level (AVL) - When 'on' is selected, the volume will attempt to stay at a constant level regardless of TV programmes and advertisements.

Digital Output - This is the digital COAX audio output. Choose from the following options:

Off	To turn off digital output
Auto	Selects the best settings automatically
PCM	Select this option if you are connecting to a Stereo Hi-fi via coax cable (Pulse-code modulation (PCM) is a digital representation of an analogue signal)

Audio Description - This allows the user to increase and decrease the 'Audio Description' volume level. (Audio description is a service available on certain programmes. It provides a description of what is happening during the selected programme for a person who is visually impaired).

Audio Delay - Enables the user to adjust setting to sync picture and audio.

Time menu

Clock - Shows the date and time.

Off Time - Allows you to set a specific time for your TV to turn off.

On Time - Allows you to set a specific time for your TV to turn on, the channel it will then display, the source it will be on and also the volume. This function can then be toggled to repeat every day or a certain day (the TV must be in standby mode for this to be effective).

Time Zone - Change your current time zone.

Sleep Timer - Lets you set the sleep timer so the television automatically switches off after a set amount of time. OFF -> 10min -> 20min -> 30min -> 60min -> 90min -> 120min -> 180min -> 240min.

Auto Standby - Set 'Auto Standby' to OFF, 3 hours, 4 hours or 5 hours.

OSD Timer - Lets you adjust the amount of time the on screen display menu stays on the screen before disappearing.

System/Hotel Lock menu

System/Hotel Lock - Allows you to lock or unlock the menu. You will be asked to enter a 4 digit password. Use the ◀ button to quit the password input or use the ▶ button to clear. Default password is 0000.

TV Button Lock - Allows you to lock the buttons on the side of the TV set.

Parental Guidance - Allows you to set the rating to block certain content based on age information.

Default Source - Allows the user to set the default source. The default source is the source the TV starts on when first switched on

Default Channel - Allows the user to set a channel as the default channel on the digital source. The default channel is the channel the TV starts on when first switched on.

Source Lock - Allows you to lock the source menu.

Channel Lock - Allows you to lock certain channels manually.

Max Volume - Allows you to adjust and set the maximum volume.

Change Password - Allows you to change the password.

Setup menu

Language - Allows you to change the language of the menu.

Audio Language - Shows the current audio language.

Subtitle Language - Shows the current subtitle language.

Hearing Impaired - This allows the user to turn on the Hearing Impaired function, this produces subtitles on the screen which provide a description of what is happening during the selected program.

PVR File System* - Allows you to view the format and performance of a USB key.

Network Configuration** - Allows you to manually set your network settings on the TV (for more information please see 'Network Configuration' section of this user guide).

Blue Screen - Changes the background when there is no input between clear and a blue background (Only available on some sources).

First Time Installation - Allows you to access the First Time Installation menu and return the TV set.

Reset TV - This resets the menus to factory settings and clears all the TV channels from the television.

Software Update (USB) - From time to time we may release new firmware to improve the operation of the television (available to download). This menu lets you install the new software/firmware onto the television. Further details of how to do this will be issued with the firmware. Contact our technical support team or refer to the 'Product Support' section of the website.

HDMI CEC (Consumer Electronic Control) - Allows HDMI devices to control each other and allows the user to operate multiple devices with one remote control. (only available with compatible devices).

LED Status - Allows the user to switch the LED Power indicator light ON or OFF, when the TV is being operated. (When this option is set to OFF the LED Power indicator light will flash when the remote control is used).

***Only available for models with built in PVR only.**

****Only available for models with Ethernet input.**

DVD setup*

*For models with built in DVD player only

TV Display - Choose from the following options:

4:3 Pan Scan	PS Traditional picture format, often used on old film
4:3 Letter Box	LB Traditional picture which has been adapted for widescreen
Wide	16:9 Widescreen picture format

Speaker Setup - Choose from the following options:

LT/RT	Converts from multi-channel sound to mono
Stereo	Converts from multi-channel sound to stereo

Dual Mono - Choose from the following options:

Stereo	Outputs two channels or sound both left and right
Mono L	Outputs left side sound
Mono R	Outputs right side sound
Mix Mono	Outputs a single channel of sound but mix between right and left

Dynamic Range - This is the difference between the quietest and loudest sounds. This setting works only with DVD discs recorded in Dolby digital.

Full	Set this to listen with the range recorded on the disc
3/4	Set this to listen with a range equivalent to a normal television
1/2	Set this to listen with a smaller difference between the maximum and minimum volume
1/4	Set this to listen with a smaller difference between the maximum and minimum volume
Off	Set dynamic range to off

TV Type - Choose from the following options:

PAL	For discs from UK/Europe, Asia, Australia etc
Multi	For both NTSC and PAL
NTSC	For discs from North America, Japan etc

Default - Choose from the following options:

Stereo	Outputs two channels or sound both left and right
Mono L	Outputs left side sound
Mono R	Outputs right side sound
Mix Mono	Outputs a single channel of sound but mix between right and left

Tip: This TV/DVD player is pre-set to play Region 2 DVDs. In the event you wish to use the TV/DVD in another country that uses different region discs, please visit www.umc-uk.co.uk, select 'Changing DVD Region' in the 'Product Support' section.

Note: To eject a DVD, press and hold the eject button on the remote control until the disc ejects.

7 Day TV guide & channel list

The TV Guide is available in digital TV mode. It provides information about forthcoming programmes (where supported by the digital channel). You can view the start and end time of all programmes and on all channels for the next 7 days and set reminders.

- 1) Press [TV GUIDE]. The following 7 Day TV Guide will appear.
- 2) Navigate through the menu using ▲▼▶◀ on the remote control.

You can now:

- Record a programme by pressing RED*
- Set a reminder by pressing GREEN
- View a previous day by pressing YELLOW
- View the next day by pressing BLUE

***Record function is only available on models with built-in PVR and when a USB stick/hard drive is connected.**

- 3) Press [EXIT] to exit the 7 day TV Guide.

Channel List

To view the channel list, please ensure that the TV is set to either the analogue or digital source and no menus or TV notifications are displayed.

- 1) Press [OK] on the remote control and the channel list menu will appear.
- 2) Scroll through the channel list by using buttons then press [OK] to view the channel that is currently highlighted.

Additional options for TV models with built in Freeview/Saorview HD:

- View HD channels by pressing RED
- View standard definition channels by pressing GREEN
- View radio channels by pressing YELLOW
- View all channels by pressing BLUE

- 3) Press [EXIT] to exit the channel list.

USB mode / media player

USB mode offers playback of various different types of content that you have saved on your USB Memory Stick.

When switching to USB source the menu screen will appear. The content will be divided into Photo, Music, Movie and Text based on file type.

- 1) You can navigate through the menus using the scroll ▲▼▶◀ buttons. To confirm the item you wish to play/view press [OK] button.
- 2) Select the drive you require. (If your drive only has 1 partition you will only see 1 item).
- 3) You can now access the item. Press OK to view.

4) Whilst viewing your item, you can control it by using the remote control buttons (below) or by pressing 'Info' to access the on-screen playback menu, you can now make your selection by using the ▲▼▶◀ and (OK) buttons on the remote control.



Tip: If you experience a playback issue, please ensure the files being used are the correct format (example - the picture plays but no sound). See separate technical specification page for compatible file types.

Note: USB extension cables are not recommended as they can cause a reduction in picture/audio quality and stoppages during play back of USB content.

USB record - digital mode*

*USB Record is only available for TV models with built in PVR.

The USB record function is available in Digital/Freeview mode when used in conjunction with a compatible USB memory stick or USB hard drive. The benefits of this are:

- Pause live TV and then playback, fast forward and rewind (up to live TV)
- One button record, if you decide you want to record the current programme.
- Easy programmable recording from the 7 day TV Guide.
- Record TV and watch/listen back on your computer/laptop.

Due to the nature of the product, it is necessary to use a high speed USB memory stick (as the TV reads from and writes to the memory stick at the same time, some memory sticks may not be suitable). You can purchase high speed memory sticks from some computer stores, alternatively, we have a selection of tested and compatible memory sticks available to purchase directly from our technical support team or website.

Minimum specification - USB memory stick:

	Freeview	Freeview HD
Read Speed	20 MB/s (Mega Byte per second)	80 MB/s (Mega Byte per second)
Write Speed	6 MB/s (Mega Byte per second)	40 MB/s (Mega Byte per second)

Pause live TV (time shift)



⏸ - Press the play/pause button and the television will pause and the live content will be recorded. To resume watching press play/pause again.

⏩ - Press fast forward to go forward in a recording (i.e. to skip adverts).

⏪ - Press fast rewind to go back in a recording (i.e. if you fast forwarded too far).

Tip: When you switch the TV to standby or change channel the Time Shift memory is wiped. To restart time shift you must press play/pause button.

One button record

At any point in time you may decide to record the current channel that you are watching. To do this you need to press the red button highlighted below.



Tip: This television contains one TV tuner, therefore it can only record the channel you are watching or record one channel while the television is in standby mode.

Note: USB record function is only available in Digital TV mode. Due to copyright laws and illegal copying/recording it is not possible to record to/from any other input/output source.

3D settings*

*3D settings are for TV models with 3D function only.

For the best 3D picture effect, watch your TV from vertical angle +/- 10°.

3D Type

When connecting a 3D product sometimes the picture maybe displayed incorrectly; choose from the following settings to correct this. You can toggle these settings by pressing the '3D' button on your remote.

3D Off	Default settings
Side by Side	3D format is commonly used in 3D broadcasting, works by halving the horizontal resolution of videos to store left and right eye images in each frame. It effectively displays up to 960 x 1080 pixel pictures to each eye, enabling TV stations to telecast 3D content at a much lower bandwidth compared with 3D Blu-ray discs. Typical supported resolutions are limited to 720p and 1080i for 3D TV programs. Users will need to manually select the correct 3D format to properly display side-by-side 3D content on a 3D TV.
Top and Bottom	3D format is alternative for 3D broadcast, which is pretty similar to side-by-side 3D except that it halves the vertical resolution instead. Available primarily up to 720p resolution, top-and-bottom 3D offers 1280 pixels horizontally. The higher pixel count is generally considered more suitable for displaying panning motion in sports programs.
Frame Packing	As its name suggests, this format stacks the left and right eye images in each frame to retain the content's original resolution for the best 3D pictures. Most, if not all, 1080p 3D Blu-ray movie discs and 720p PS4 3D games are produced utilizing this technique. Another key differentiator is that all 3D TVs should be able to automatically detect frame-packing 3D signals and correctly display the content without user intervention.
Line by Line	The picture signals for left and right eyes are interlaced in alternate lines. The left eye's resolution is halved then placed in the odd lines of the video stream. Correspondingly, the right eye's resolution is halved then placed in the even lines of the video stream. When combined the video stream totals 1920x1080.

Exchange 3D L/R

Change picture sequence for different viewing.

2D to 3D	Changes the picture from regular 2D to 3D.
3D to 2D	Changes the picture from 3D to regular 2D.
3D to 2D	Depth of pictures converted from 2D to 3D.
Depth	

PC settings*

* only for devices with VGA connector.

Auto Adjust - Lets you automatically configure the television to be used as a computer monitor.

H Off Set - Changes the horizontal position of the picture.

V Off Set - Changes the vertical position of the picture.

Size - Increase picture size.

Phase - To adjust delay time of phase in order to reduce the noise of picture

Position Reset - Changes back to the original settings

Tip: If the computer is left in-active for a period of time, the television will switch into a 'sleep' state (the screen will power off to save power). To switch back on press the standby button.

Tip: If you do not press any buttons for 10 seconds, the menu will automatically exit. You can change the length of time before the menu exits automatically - see 'OSD Timer' on Time Menu page.

Option 2) Connecting your TV to your Sky box (when your Sky box is located in a different room to the TV)

Please note, if you are adding a 'Magic Eye/TV Link' to your system so that you can use your Sky remote control to change the Sky channel in the room where the 2nd TV is located, please refer to the instructions included with the TV link/magic eye in order to ensure the RF or RF2 output on your Sky box is powered on. (The red LED light on the TV link/magic eye will light up if the RF / RF2 output is correctly set up) If you do not have the instructions that came with the TV link/magic eye, instructions on how to do it can be found on our website.

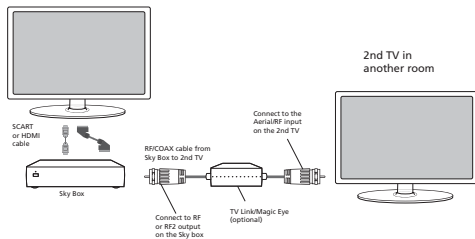

- 1) To tune the TV to the Sky box, on the 2nd TV, select the 'Analogue' input source.
- 2) Select the channel that you wish to store the Sky box/channel on. (If you do not use channels 1-5 because you no longer have analogue terrestrial channels after digital switchover, you may choose to select channel 1 to store the Sky box/channel, if you still have and use analogue channels 1-5, you may for example decide that channel 6 is the best option for you)
- 3) Press the corresponding number on the remote control to select the desired analogue channel chosen as per point 2 above.
- 4) On the TV remote control, press Menu. Now navigate through the menus to select Manual Tuning or Analogue Manual Tuning (refer to the Tuning/Channel menu section of this user guide if necessary)
- 5) Manually tune in the channel (usually, the Sky box is at a frequency between 800Mhz and 850Mhz) once the Sky box/channel is found, press 'OK' to store it.

If you wish to use your Sky remote to operate the TV's functions, you will need a Sky remote control (Revision 9 or later) and you will need to program a 4 digit code into it.

Using a Sky Remote or a Universal Remote to operate your TV

Sky Remote Control - If you wish to use your Sky remote to operate the basic functions of your TV, you need to program a 4 digit code into it. Please note - you will need a Sky Revision 9 remote control (or later). If you wish to upgrade/replace your existing Sky remote control to the latest version, you can do so on our website.

Universal Remote Control - If you wish to use a Universal remote control to operate your TV, please refer to the website for a full list of codes. (Please note we only have codes for One for All branded remote controls, if you have an alternative brand of Universal remote, please refer to the manufacturer for the code.)

Using your TV with a Sky digital set top box

Option 1) Connecting your TV to your Sky box (when both the TV and Sky Box are located in the same room)

Depending on your Sky Box & TV model, connect either by SCART or HDMI cables (available separately)

If connecting by SCART, select the 'Input source' on the TV as SCART. If your TV model does not have SCART, please refer to the 'Connections' pages in this user guide for alternative ways to connect.

If connecting by HDMI, select the 'Input source' on the TV as HDMI (if the TV has more than 1 HDMI port, ensure you select the input source to match the HDMI numbered port on the rear of the TV)

If you wish to use your Sky remote to operate the TV's functions, you will need a Sky remote control (Revision 9 or later) and you will need to program a 4 digit code into it.

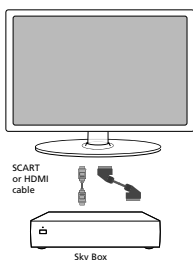

Sky remote
4-digit code:
2134

Network configuration*

*Network configuration is only available for TV models with Ethernet input.

The Network connection is only intended to access Pay TV services from your Freeview/Saorview broadcaster. Please note, the TV cannot be used for internet access.

For the network configuration to work the TV will need to be connected to your home network via an Ethernet cable, with these requirements in place the TV will connect to the network automatically.

If you are looking to change the configuration to a static IP address this can be done by following the instructions below.

1



2



3

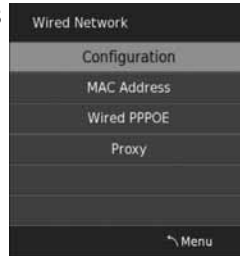

- 1) In the Setup Menu you will need to highlight and select Network Configuration.
- 2) When the Network menu appears highlight and select Wired Network.
- 3) Next the Wired Network menu will appear please highlight and select Configuration.

4

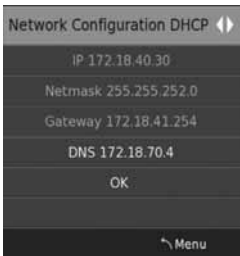

5



6

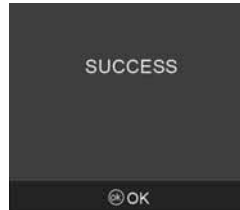

- 4) The Network Configuration menu allows you to choose between DHCP and Static.

DHCP - Will automatically connect the TV to your home network (this is the default setting and is highly recommended).

Static - Is an advanced option and allows you to manually change the IP, Netmask, Gateway and DNS information.

- 5) If the static option is chosen you will be able to scroll down and manually change the IP, Netmask, Gateway and DNS information.
- 6) When the connection process is completed with either DHCP or Static option the Success screen will appear.

Frequently asked questions

General (For TV models with COAX output only)	I would like to have louder sound by connecting additional speakers.	1) Use the 3.5mm headphone output and a 3.5mm to phono cable (available separately) to connect to an amplifier/surround sound system. Please note this will deactivate the TV's built in speakers. 2) Connect a COAX cable from the TV's COAX output to your amplifier/surround systems COAX input.
General (For TV models with digital optical audio output)	I would like to have louder sound by connecting additional speakers. For TV models with digital optical audio output.	1) Use the 3.5mm headphone output and a 3.5mm to phono cable (available separately) to connect to an amplifier/surround sound system. Please note this will deactivate the TV's built in speakers. 2) Connect a digital optical audio cable from the TV's digital optical audio output to your amplifier/surround systems digital optical audio input.
General	Why are some options in the menu unavailable and greyed out.	Some options are only available in certain sources, i.e. HDMI. They are unavailable in the other sources where they have no affect.
General	Can I stop my TV automatically turning off after 4hrs?	Yes, in the 'Time' menu settings, scroll down to Auto standby and select OFF.
TV	I have tuned in Digital TV but I am not receiving any or all of the channels and/or the channels I receive are breaking up.	1) Check you are in an area that can receive Freeview/Saorview, visit www.freeview.co.uk or www.saorview.ie 2) Check you are using an aerial that is able to receive a good digital signal. In most cases, you will need an outdoor digital hi-gain/wideband aerial. In areas that have excellent digital coverage, you may be able to use a loft type aerial but it is highly likely that you will also need to connect a booster between the back of the TV and the TV aerial wall socket. Unfortunately, to receive a good enough digital signal, it is not possible to use a portable/indoor type aerial.
TV	I have re-tuned my television but when I switch it off it is not storing the channels.	If the TV does not save the channels when you power it off, it's likely the channel database has become corrupt. 1) Turn off the TV. 2) Remove the RF/Aerial cable from the rear of the TV and then turn the TV back on again. 3) Using the remote control, press Menu followed by 8-8-8-8 to enter the initial setup/first time installation menu. 4) Press OK (let the TV run the full tuning process). 5) Once completed, turn off the TV, reconnect the RF/Aerial cable then turn the TV back on again. 6) Repeat steps 3 & 4.
VCR/DVD Recorder	I have connected the TV to my VCR or DVD Recorder via SCART but it is not recording.	In addition to connecting via SCART, you should connect the aerial cable from the wall socket to your VCR/DVD Recorder and another aerial cable from the VCR/DVD Recorder to the TV.
Game Consoles	I have connected my Playstation/Xbox to the TV via HDMI, but I am not receiving any pictures or sound on my Television.	1) Ensure the TV's source is set to HDMI. 2) Check your settings on your Playstation/Xbox are as per the Playstation/Xbox instruction manual.
Game Consoles	I have connected my Playstation/Xbox to the TV via Component cables (red, green & blue) but I am not receiving any sound.	Component cables only provide HD pictures. For the sound you will need to connect the red & white audio cables on the Playstation/Xbox to the red & white phono inputs (or mini AV input where fitted) on the rear of the TV. Please refer to the 'Connections' pages.
System Lock	I have changed the password on the television and now forgotten it.	There is a master password of 4711, to gain access to the TV menu and reset the normal password.
USB Mode	I have inserted a USB Memory Key, but the TV does not recognise it.	Ensure the USB Memory Key is formatted to type FAT32.
USB Mode	Using a USB portable hard drive / larger than 32GB.	If you wish to use a portable hard drive larger than 32GB, please note that it must be formatted to the FAT32 file system in order to operate on this TV. Windows XP/Vista computers are only capable of formatting up to 32GB, therefore, you will need a software programme/utility to format larger hard drives. Please refer to the website, www.umc-uk.co.uk , for more information.

Frequently asked questions

DVD (For TV models with DVD only)	I have inserted a disc but it is not playing.	<ol style="list-style-type: none"> 1) Ensure you have inserted the disc facing the correct way. 2) Ensure the disc is clean and is not scratched. 3) Some copied discs will not play. 4) Check the DVD is a region 2 disc – to change the region of the DVD player, refer to www.umc-uk.co.uk, select 'Changing DVD Region' in the 'Product Support' section
DVD (For TV models with DVD only)	I have pressed the eject button but the disc is not coming out.	To eject the disc hold the stop/eject button for 4 seconds.
USB Record (For TV models with USB record only)	I cannot change the channel, access the menu or use the red button.	During time shift you cannot change the channel, access the menu or use the red button.
USB Record (For TV models with USB record only)	When using the USB to record the picture 'breaks up' or experience loss of sound.	Check the USB memory stick meets the minimum read speed requirements. Standard definition channels require a read speed of 20 MB/s (Mega Byte per second) and a write Speed of 6 MB/s (Mega Byte per second) HD channels require the read speed of 80 MB/s (Mega Byte per second) and a write speed of 40 MB/s (Mega Byte per second). USB 3.0 sticks should be used where possible.
Freeview HD (For Freeview HD TV models only)	I cannot access all Freeview channels.	Some data channels for Freeview can only be obtained when the TV's ethernet port is connected to your router.
Freeview HD (For Freeview HD TV models only)	I cannot find the Freeview HD channels.	Freeview HD channels found during tuning will be placed in channel positions above 100. For example, 101 (BBC1 HD), 102 (BBC2 HD) etc.
3D mode (For 3D TV models only)	The picture is not displaying correctly.	Press the 3D button to toggle through the different 3D picture formats.
3D mode (For 3D TV models only)	I have downloaded a 3D movie but it will not play via USB.	3D mode is not supported via USB.



BLA/MAN/0285