

Technika

HD Ready LED TV with Saorview, DVD & USB Media Player

User Guide

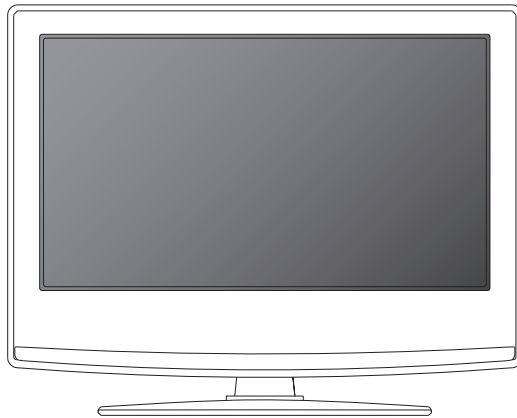

Model No
LED19-248COMI

IMPORTANT SAFETY INSTRUCTIONS



Please read these instructions. All the safety and operating instructions should be read before the appliance is operated.

Warnings

- To reduce the risk of fire, electric shock or damage to the television, do not expose it to dust, rain or moisture, or place any objects filled with liquids on or near the television.
- Do not place the television in a confined space, ensure that nothing can obstruct the ventilation openings at the rear of the television.
- Dispose of this television and any components including batteries in an environmentally friendly manner. If in doubt, please contact your local authority for details of recycling.
- To prevent spread of fire, keep candles or other open flames away from this product at all times



Safety

- For your safety, this appliance is fitted with a fused moulded 3 pin mains plug. Should the fuse need to be replaced, ensure that any replacement is of the same amperage and approved with the BSI mark.
- Never try and replace the mains plug unless you have adequate qualifications and are legally authorised to do so. In the event that a replacement Mains cable is required, contact the manufacturer for a suitable replacement.
- Never use the television if it is damaged in any way.
- Always place the television on a flat level surface avoiding anywhere which may be subject to strong vibration.
- Ensure the television is not placed on top of the power cable as the weight of the television may damage the cable and cause a safety hazard.
- Never place mobile phones, speakers or any other device which may cause magnetic or radio interference with the television. If interference is apparent, move the device causing the interference away from the television.

Maintenance

- To clean this unit, wipe with a soft, dry cloth. If the surfaces are extremely dirty, use a soft cloth dipped in a soap and water solution or a weak detergent solution.
- Use eyeglass cleaner to remove stubborn dirt from the LCD/LED Screen.
- Never use alcohol, paint thinner or benzene to clean this unit.
- Before using a chemically treated cloth, read the instructions that came with the cloth carefully.

CAUTION: If water or other liquid enters the television through the display panel surface, a malfunction may occur.



Packaging

- The safest way to transport your item is in the original box/packaging - please save your packaging for this.
- You will need original box/packaging in the event of warranty/service repair or support. We are unable to carry out warranty/service if you are unable to package it correctly.



Please read these instructions. All the safety and operating instructions should be read before the appliance is operated.

Important Information Regarding Use of Video Games, Computers, Captions or Other Fixed Image Displays

The extended use of fixed image program material can cause a permanent "shadow image" on the LCD panel.

This background image is viewable on normal programs in the form of a stationary fixed image. This type of irreversible LCD/LED panel deterioration can be limited by observing the following steps:

1. Reduce the brightness/contrast setting to a minimum viewing level.
2. Do not display the fixed image for extended periods of time.
3. Turn the power off when not in actual use.

Examples of images that you need to watch out for are as follows (this is not an exhaustive list):

- TV Channel Logos: e.g. Shopping channel logos and pricing displays-especially if they are bright and stationary. Moving or low-contrast graphics are less likely to cause ageing of the screen.
- Time Displays
- Teletext: Do not view a stationary page for long period of time
- TV/DVD Menus: e.g. Listings of DVD disk content
- Pause Mode: Do not leave the TV in pause mode for long periods of time, e.g. When watching DVDs or videos.

Important - Once 'shadow image/screen burn' occurs, it will never disappear and is not repairable under warranty.

How do I dispose of this product?

UK: Waste electrical products should not be disposed of with household waste. Separate disposal facilities exist. For your nearest facilities, please see www.recycle-more.co.uk or in store for details.

ROI: Waste electrical products should not be disposed of with household waste. Separate disposal facilities exist. Check with your Local Authority or retailer for recycling advice.

Batteries

- Do not expose batteries to high temperatures, excessive heat, prolonged sunshine, fire etc as may casue leakage, explosion or ignition.
- Observe the correct polarity when inserting batteries.
- Do not use different types of batteries together or mix old and new batteries.
- Dispose of batteries in an environmentally friendly way.
- Certain regions may regulate the disposal of batteries.
Please consult your local authority.



Cd

CAUTION:



This caution label is located on the rear panel of the unit

THIS UNIT IS A CLASS 1 LASER PRODUCT. HOWEVER THIS UNIT USES A VISIBLE LASER BEAM WHICH COULD CAUSE HAZARDOUS RADIATION EXPOSURE IF DIRECTED. BE SURE TO OPERATE THE PLAYER CORRECTLY AS INSTRUCTED. WHEN THIS UNIT IS PLUGGED INTO THE WALL OUTLET, DO NOT PLACE YOUR EYES CLOSE TO THE OPENINGS TO LOOK INTO THE INSIDE OF THIS UNIT.

USE OF CONTROLS OR ADJUSTMENTS OR PERFORMANCE OF PROCEDURES OTHER THAN THOSE SPECIFIED HEREIN MAY RESULT IN HAZARDOUS RADIATION EXPOSURE.
DO NOT OPEN COVERS AND DO NOT REPAIR YOURSELF. REFER SERVICING TO QUALIFIED PERSONNEL.

CONTENTS

Manufacturers Guarantee Information	3
Important Safety Instructions	4-5
What is included in the box	8
Attaching/Detaching the stand and wall mounting	9
Getting Started - Initial Set Up	11
TV Buttons and Input Source Menu	12
Remote Control	13
Connections	14-15
TV Menu Operation	16-22
Channel Menu	16
Picture Menu	17-18
Sound Menu	19
Time Menu	20
Lock Menu	21
Option Menu	22
DVD Menu	23
7 Day TV Guide	24
USB Mode / Media Player	25
General Information	26-29
Using your TV with a digital set top box	26
Frequently Asked Questions	27
Technical Specifications	28
Index	29

WHAT IS INCLUDED IN THE BOX

Accessories

Included with this TV are the following accessories:

1 x User Guide

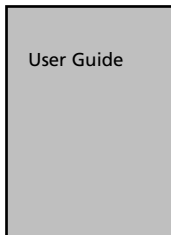

1 x Remote Control



1 x Quick Start Guide

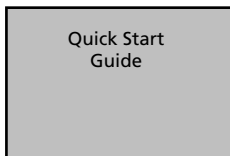

2 x AAA Batteries



1 x TV



1 x Stand



1 x RF Cable



1 x Stand neck + screws

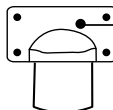

Please save your packaging as you will need this in the event of warranty/service repair or support. We are unable to carry out warranty/service if you are unable to package it correctly. The safest way to package your item in the event of warranty/service repair is in its original box/packaging.

ATTACHING/DETACHING THE STAND

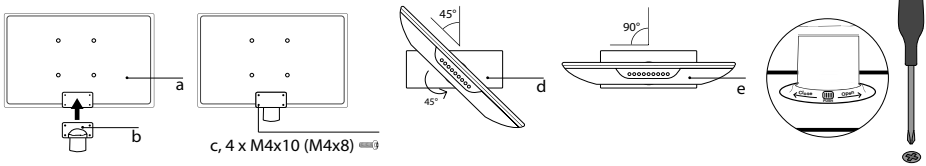

For the assembly you will need a screwdriver.

Place TV body on flat surface panel facing downwards to avoid damage to the panel.

1. Attach the stand neck (b) to the body of TV unit (a) with 4 screws (c).
2. Insert the TV into the stand at 45 degrees (d).
3. Twist the TV into the CLOSE position until it clicks into place (e).

Please follow the instructions described in the instructions for safe placing your TV!

Detaching the Stand

- 1) To remove the base, press close button and rotate 45 degrees.
- 2) Remove the 4 screws highlighted



IMPORTANT - Before drilling any holes in the wall ensure you are not drilling where there could be any electric wires, water or gas pipes.

Wall mounting the TV

This television requires a VESA 100 wall mount, or equivalent.

- 1) Remove the four screws highlighted below.
- 2) The wall mount can now be easily attached to the mounting holes on the rear of the TV. These holes are indicated in the picture below.



For optimum viewing, if wall mounting the TV higher than eye level, the TV should be tilted downwards so that the TV's screen is 'face on'. See fig 1 and 2

Important – If wall mounting this TV, only use the screws already provided in the wall mounting holes. Using other screws which are longer could cause irreparable damage to internal parts.

fig 1

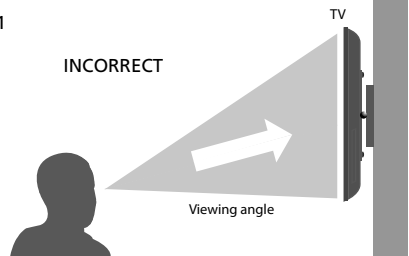
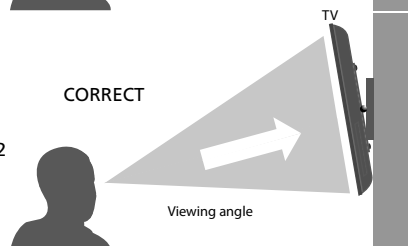

fig 2



GETTING STARTED - INITIAL SET UP

1) Using the RF cable supplied, connect the TV to the TV Aerial wall socket (Fig A)

2) Connect the power cable to the Electrical outlet (Fig B)



3) Switch on the television using the power on/off switch.

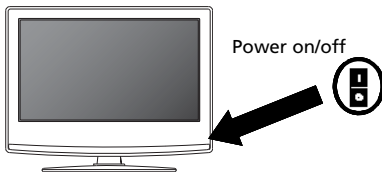

4) Insert the batteries supplied into the Remote control and press the Standby button to power on the TV

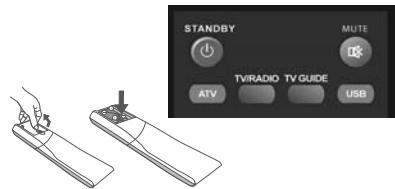

5) You will now be welcomed with the initial set-up screen.

If it does not appear, on the remote control, please press [MENU] then 8-8-8-8 and the menu will appear. Press OK on the remote control and tuning will start.



6) After tuning the following screen will appear.

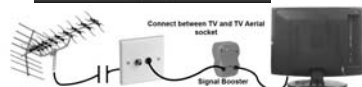
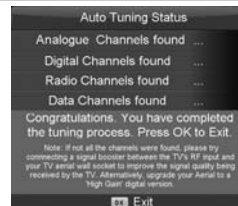

If you are missing channels, the reason for this is likely to be signal strength, you should consider connecting signal booster and re-tuning the TV.

Tip: If the TV finds some, but not all, of the Digital channels, the TV is functioning correctly but the signal being received is not strong enough. (The signal strength needs to be above 85% - you can see the signal strength the TV is receiving when you change channels/ programmes) you will need to increase the signal reception in order to receive all of the channels available. The most economical way to do this is by purchasing and connecting a 'signal booster' in between the TV and the TV aerial socket. If this does not solve the problem, you will need to upgrade the TV aerial to a digital hi-gain compatible aerial

TV BUTTONS & SOURCE MENU

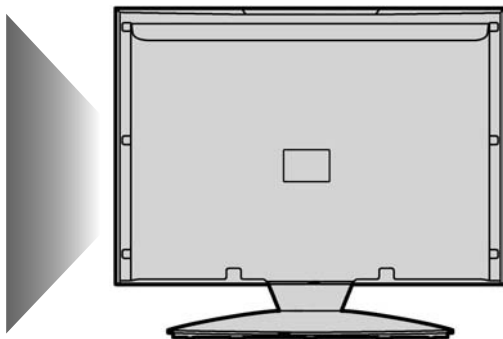

1	Play/Pause	Play or pause the disc
2	Eject	Ejects disc
3	VOL+	Volume up and menu right
4	VOL-	Volume down and menu left
5	CH+	Programme / channel up and menu up
6	CH-	Programme / channel down and menu right
7	Menu	Display Menu / OSD
8	Source	Display the input / Source menu
9	Power	Standby power On/Off

Choosing Mode Input/Source

To switch between the different input/connections.

A) Using the buttons on the remote control:

- 1) Press [SOURCE/ AV] - The source menu will appear
- 2) Press [V] or [Λ] to select the input you require.
- 3) Press [OK]

B) Using the buttons on the Television:

- 1) Press [SOURCE]
- 2) Scroll up / down using CH+ / CH- buttons to the input/source you require
- 3) Press Vol+ to change input/source to the one selected.

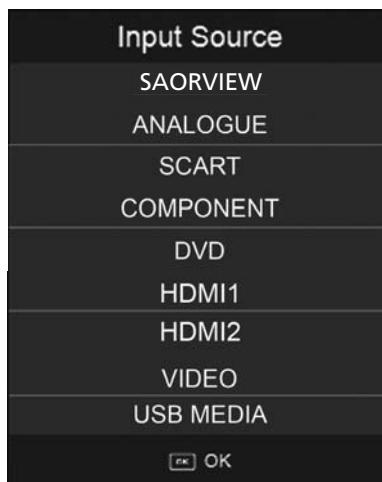

REMOTE CONTROL

- 1** STANDBY - Switch on TV when in standby or vice versa
 MUTE - Mute the sound or vice versa
 TV/RADIO - Switch to Saorview and switch between TV and radio in Saorview mode
 TV GUIDE - Opens the 7 Day TV Guide (Saorview mode)
 ATV - Switch to analogue TV source
 USB - Switch to USB Source
 DVD - Switch to DVD source
 EJECT - Eject disc in DVD mode

- 2** S.MODE - Scrolls through sound mode options
 P.MODE - Scrolls through picture mode options
 ⏪ - To restart the current chapter
 ⏩ - To advance forward to the next chapter
 ⏸ - To stop the playback
 ⏮ - To play in fast rewind mode
 ⏭ - To play in fast forward mode
 ⏹ - To play/pause

- 3** SOURCE/AV - To display the input/source menu
 INFO - Press once for now/next channel information
 Press twice for programme information about current programme
 (▲/▼/◀/▶/OK) - Allows you to navigate the on-screen menus and adjust the system settings to your preference
 MENU - To display OSD menu
 EXIT - To exit all menus
 NUMBER BUTTONS - 0 – 9 to select a TV channel directly.
 ⏪ - To return to the previous channel viewed
 FAV - To display favourites menu

- 4** VOL ▲/▼ - To increase / decrease the sound level
 SUBTITLE - To switch the dialogue at the bottom of the screen (on/off)
 ASPECT - To switch the screen between the different picture formats
 AUDIO - To change the audio language (if available)
 SLEEP - Press repeatedly to cycle through the sleep options
 CH ▲/▼ - To increase or decrease the channel being watched
 GOTO - DVD mode - To go to a specific chapter
 A-B Repeat - DVD mode - Press once to set point, press a second time to return to point
 ANGLE - DVD mode - Select different angle of DVD (if available)
 REPEAT - DVD mode - To repeat playback

- 5** D.DIS - DVD mode - To display the current disc information
 ZOOM - DVD mode - To zoom in
 **SIZE - Teletext mode - To change the display size in Teletext mode
 DISPLAY - To switch off the screen when listening to radio
 DVD SETUP/TEXT - DVD mode - To display the DVD setup menu
 **Teletext mode - To enter Teletext
 D.MENU/INDEX - DVD mode - To display the DVD disc menu
 **Teletext mode - To display the index page
 TITLE/REVEAL - DVD mode - To display the DVD title menu
 **Teletext mode - To reveal or hide the hidden words.
 HOLD - Teletext mode - Hold current page which is displayed



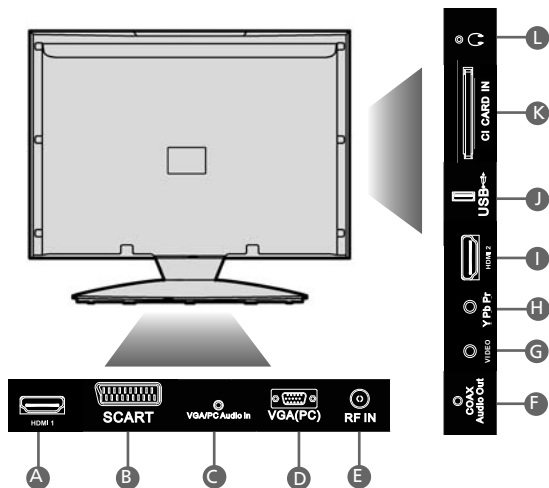

A	HDMI 1	HDMI input
B	SCART	SCART input
C	VGA(PC) Audio In	3.5mm PC audio input
D	VGA(PC)	VGA-PC input
E	RF IN	RF / TV Aerial Input
F	COAX Audio Out	Digital Coax output
G	VIDEO	Video and Audio input for Video&Component
H	Component HD	Component HD Input
I	HDMI 2	HDMI input
J	USB	USB port
K	CI CARD IN	Common Interface Card Input
L	HEADPHONES	3.5mm Headphone output

CONNECTIONS

Connecting a Camcorder, Camera or Games Console

TVs Input / Source should be set to Video

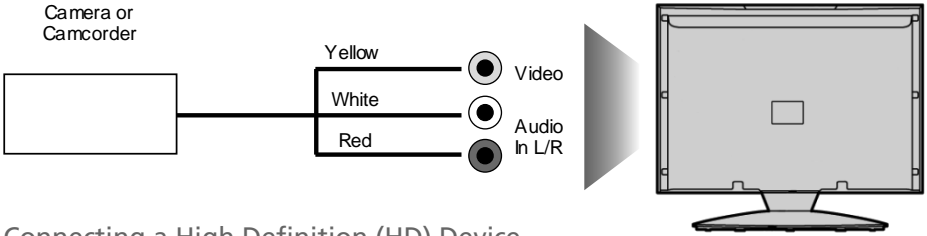

Connecting a High Definition (HD) Device

Option 1 - via HDMI to HDMI cable

A HDMI cable can output both video and audio and enables you to enjoy digital-quality video and audio with minimal loss of quality.

TVs Input/Source should be set to HDMI.

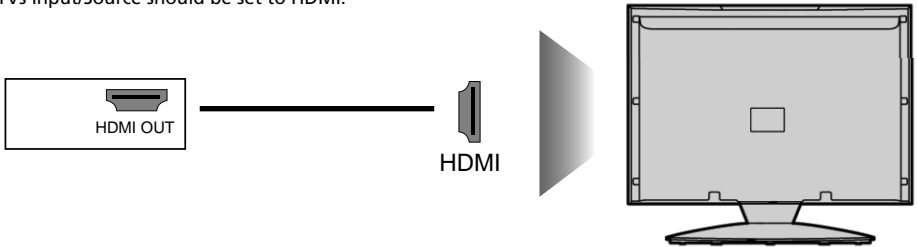

Option 2 - via Component cable

If you are supplied with a cable from the device which has RED, GREEN, BLUE, RED & WHITE connectors you must connect via Component (for picture) and by phono cable (for sound).

TV Source should be set to Component.

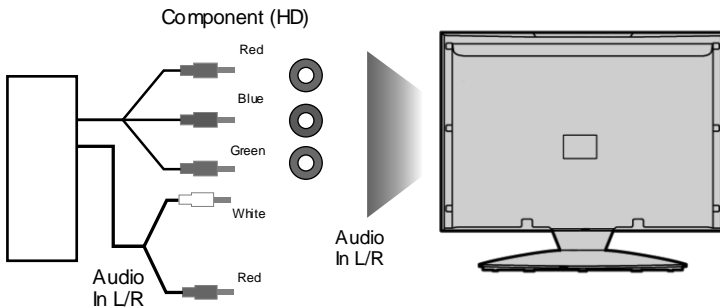

CHANNEL MENU



To access this menu, press [MENU] button on the remote control. To enter a menu press [OK]

If you wish to make changes to any of the default settings, use the scroll  buttons. To confirm any settings press [OK] button.

To exit this menu at anytime, press [EXIT] button.

Auto Tuning - Allows you to retune the television for all digital channels, digital radio stations and analogue channels.

Digital Manual Tuning- Allows you to manually tune your digital signal

Analogue Manual Tuning - Allows you to manually tune your analogue signal

Programme Edit - Allows you to delete, skip and add favourite channels.



Signal Info -Displays signal strength and quality information.

CI Information - Pay per view services require a "smartcard" to be inserted into the TV.

If you subscribe to a pay per view service the provider will issue you with a 'CAM' and a "smartcard". The CAM can then be inserted into the COMMON INTERFACE PORT (CI Card In).

PICTURE MENU

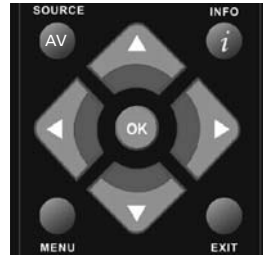

To access this menu, press [MENU] button on the remote control. To enter a menu press [OK]

If you wish to make changes to any of the default settings, use the scroll ▲▼▶◀ buttons. To confirm any settings press [OK] button.

To exit this menu at anytime, press [EXIT] button.

Picture Mode - Choose from the following presets

Standard	Default settings
Dynamic	Recommended settings for fast moving pictures
Mild	Set to be lighter in colour and less bright
User	Lets you manually alter all the settings

Contrast - Switch the balance between black and white

Brightness - Increase or decrease the brightness of the picture

Colour - Increases the colour from black and white

Sharpness - Increase or decrease the sharpness of the picture

Tint - Lets you increase or decrease the level of tint within the picture

Noise Reduction - Choose from the following presets

Off	Turns noise reduction off
Low	Minor system adjustment
Middle	Medium system adjustments
High	Maximum system adjustments

Tip: If you do not press any buttons for 10 seconds, the menu will automatically exit. You can change the length of time before the menu exits automatically - see 'Menu Duration' section.

PICTURE MENU



To access this menu, press [MENU] button on the remote control. To enter a menu press [OK]

If you wish to make changes to any of the default settings, use the scroll ▲▼▶◀ buttons. To confirm any settings press [OK] button.

To exit this menu at anytime, press [EXIT] button.

Aspect Ratio - Within the UK the picture format varies depending on the channel/broadcast. There are a number of different options to best meet your needs

Auto

Automatically displays the best picture format. So the picture is in the correct position. May have black lines At the top/bottom and/or sides.

Original

Will display the picture from the broadcaster without any change

Zoom 1-2

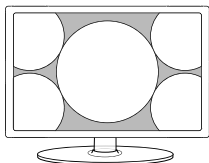

The picture is the correct proportion but zoomed in to fill the screen

4:3

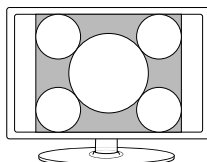

Displays the 4:3 picture in its original size. Side bars are shown to fill the 16:9 screen

16:9

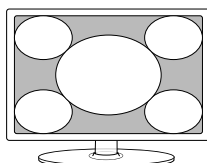

Fills the screen with a regular 16:9 signal and 4:3 picture format will be stretched to fill the screen

Panorama

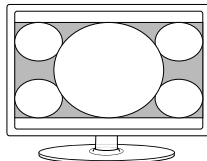

Displays the 14:9 picture in the correct proportion. As a result side bars are shown on the screen

SOUND MENU



To access this menu, press [MENU] button on the remote control. To enter a menu press [OK]

If you wish to make changes to any of the default settings, use the scroll  buttons. To confirm any settings press [OK] button.

To exit this menu at anytime, press [EXIT] button.

Sound Mode - Choose from the following presets

User	Default settings
Music	Emphasises music over voices
Movie	Provides live and full sound for movies
Personal	Selects your personal sound settings
Sports	Emphasises sound for sports

Tip: Treble and bass levels can only be adjusted when the sound mode 'Personal' is selected.

Treble - To adjust the amount of high frequency within the sound

Bass - To adjust the amount of low frequency within the sound

Balance - To switch the sound between the left and right speakers

Auto Volume Level (AVL) - When 'on' is selected, the volume will stay at a constant level regardless of input/source

Surround Sound - Allows you to turn surround sound ON or OFF

AD Volume - Increase or decrease the Audio Description volume

Audio Delay - Allows you to sync sound and picture on Digital source.

SPDIF Mode - This is the digital COAX Audio output. Choose from the following options:

Off	Off
Bitstream	Select this option if you are connecting to a Dolby Digital 5.1 surround sounds amplifier via coax cable (True digital signal)
PCM	Select this option if you are connecting to a Stereo Hi-fi via coax cable (Pulse-code modulation (PCM) is a digital representation of an analogue signal)

TIME MENU



To access this menu, press [MENU] button on the remote control. To enter a menu press [OK]

If you wish to make changes to any of the default settings, use the scroll  buttons. To confirm any settings press [OK] button.

To exit this menu at anytime, press [EXIT] button.

Clock - Set the date and time

Off Time - Allows you to set a specific time for your TV to turn off

On Time - Allows you to set a specific time for your TV to turn on, the channel it will then display, the source it will be on and also the volume. This function can then be toggled to repeat every day or a certain day.

Sleep Timer - Lets you set the sleep timer so the television automatically switches off after a set amount of time. Off -> 10min -> 20min -> 30min -> 60min -> 90min -> 120min -> 180min -> 240min

Auto sleep - If no signal is received after a period of time the Television will turn itself off

Time Zone - Change your current time zone

LOCK MENU



To access this menu, press [MENU] button on the remote control. To enter a menu press [OK]

If you wish to make changes to any of the default settings, use the scroll **▲▼▶◀** buttons. To confirm any settings press [OK] button.

To exit this menu at anytime, press [EXIT] button.

Lock Channel - Allows you to lock or unlock specific channels.

Set Password - You will be asked to enter a 4 digit password use the **◀** button to quit the password input.

Use the **▶** button to clear. Default password is 0000

Block Program - Allows to completely block certain channels

Parental Guidance - Turns the parental guidance function on and off

OPTION MENU



To access this menu, press [MENU] button on the remote control. To enter a menu press [OK]

If you wish to make changes to any of the default settings, use the scroll  buttons. To confirm any settings press [OK] button.

To exit this menu at anytime, press [EXIT] button.

OSD language - Allows you to change the language of the menu

Audio Languages - In certain situations you will be given the ability to change audio language

Subtitle Languages - In certain situations you will be given the ability to change subtitle language

OSD Duration - Lets you adjust the amount of time the On Screen Menu stays on the screen before disappearing

Blue Screen - Changes the background when there is no input between clear and a blue background (Only available on some sources)

Country - Shows you the country that has currently been selected

Reset Factory default

Reset Menu System - This resets the menus to factory settings.

Reset Menu System - This clears all the TV channels from the television

Software Update (USB) - From time to time we may release new firmware to improve the operation of the television (available to download). This menu lets you install the new software/firmware onto the television. Further details of how to do this will be issued with the firmware. Contact the helpline or refer to the 'product support' section of the website.

DVD MENU

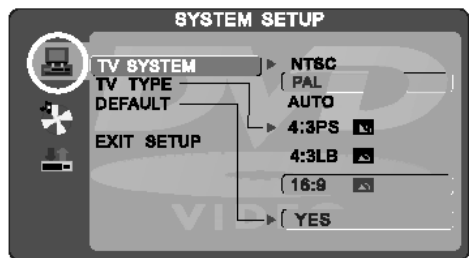

To access this menu, press [D. MENU] button on the remote control.

If you wish to make changes to any of the default settings, use the scroll  buttons. To confirm any settings press [OK] button.

To exit this menu at anytime, press [EXIT] button.

TV System - Choose from the following options

NTSC	Normally used for discs from North America, Japan etc
PAL	The standard for discs from UK/Europe, most of Asia, Australia etc
Auto	For both NTSC and PAL

TV Type - Choose from the following options

4:3PS	Traditional picture format, often used on old film
4:3 LB	Traditional picture which has been adapted for widescreen
16:9	Widescreen picture format

Default - This option allows you reset all DVD settings.

Tone - Choose from the following options

+	Increases the treble (high frequency sound)
-	Increases the bass (low frequency sound)

Dynamic Range - This is the difference between the quietest and loudest sounds. This setting works only with DVD discs recorded in Dolby digital.

Full	Set this to listen with the range recorded on the disc
4/8	Set this to listen with a range equivalent to a normal television
2/8	Set this to listen with a smaller difference between the maximum and minimum volume

Dual Mono

Stereo	Outputs 2 channels of sound both left and right
Mono L	Outputs left side sound
Mono R	Outputs right side sound
Mix Mono	Outputs a single channel of sound but mix between right and left

7 DAY TV GUIDE

TV Guide is available in Digital TV mode. It provides information about forthcoming programmes (where supported by the Saorview channel). You can view the start and end time of all programmes and on all channels for the next 7 days and set reminders.

1) Press [TV GUIDE]. The following 7 Day TV Guide will appear.

7 Day TV GUIDE

10 Years Younger: The Challenge
Season 2
Support worker Janice Cassidy's lifestyle of long working hours and a penchant for tanning has taken its toll, while the stress of bringing up two daughters and heavy smoking has affected interior designer Shere Morady. Surgeon Jan Stanek and the team set out to provide

04 Aug 2010 10:42

BBC1	05:00-06:00	10 Years Younger: The Challenge
BBC2	06:00-06:30	The Simpsons
ITV1	06:30-07:00	Hollyoaks
Channel 4	07:00-08:00	Channel 4 News
five	08:00-09:00	How to Look Good Naked
BBC3	09:00-10:00	Newlyweds: The One Year Itch
BBC4	10:00-11:15	Big Brother
ITV2	11:15-11:45	The Big Bang Theory

Remind
Prev Day
Move View
Next Day
Display

2) Navigate through the menu using ▲▼▶◀

You can now:

Set a reminder by pressing GREEN

View a previous day by pressing YELLOW

View the next day by pressing BLUE

3) Press [EXIT] to exit the 7 day TV Guide.

USB MODE / MEDIA PLAYER

USB mode offers playback of various different types of content that you have saved on your USB Memory Stick.

Please refer to technical specification page for compatible file types

On switching to USB source the above menu screen will appear. The content will be divided into Photo, Music, Movie and Text based on file type.



1) You can navigate through the menus using the scroll ▲▼▶◀ buttons. To confirm the item you wish to play/view press [OK] button.

2) Select the drive you require. (If your drive only has 1 partition you will only see 1 item).



3) You can now access the item. Press OK to view.



4) While viewing you control the item using



or by pressing (i) and using ▲▼▶◀ and (OK)

USING YOUR TV WITH A SKY DIGITAL SET TOP BOX

Option 1) Connecting your TV to your Sky box (when both the TV and Sky Box are located in the same room)

Depending on your Sky Box and TV model, connect either by SCART (or if no SCART connector is included with your TV, connect via a SCART to AV cable) or via an HDMI cable (SCART to AV and HDMI cables are available separately)

If connecting by SCART cable to both the Sky Box and TV, select the 'input source' as SCART.

If connecting by SCART to AV cable (SCART on one end connected to your Sky box and a Red/White and Yellow connector on the other end that connects to the TV) select the 'input source' as AV.

If connecting by HDMI, select the 'Input source' on the TV as HDMI (if the TV has more than 1 HDMI port, ensure you select the input source to match the HDMI numbered port on the rear of the TV)

If you wish to use your Sky remote to operate the TV's functions, you will need a Sky remote control (Revision 9 or later) and you will need to programme a 4 digit code into it. See bottom of this page.

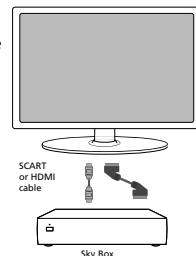

Option 2) Connecting your TV to your Sky box (when your Sky box is located in a different room to the TV)

Please note, if you are adding a 'Magic Eye/TV Link' to your system so that you can use your Sky remote control to change the Sky channel in the room where the 2nd TV is located, please refer to the instructions included with the TV link/magic eye in order to ensure the RF or RF2 output on your Sky box is powered on. (The red LED light on the TV link/magic eye will light up if the RF / RF2 output is correctly set up) If you do not have the instructions that came with the TV link/magic eye, instructions on how to do it can be found on our web site.

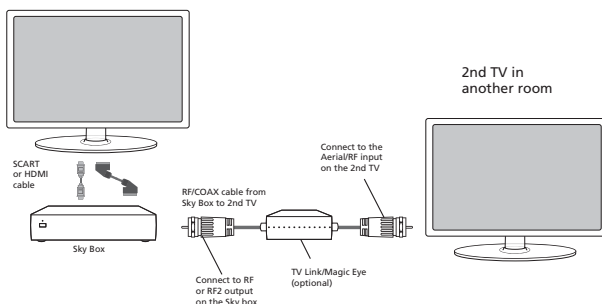

- 1) To tune the TV to the Sky box, on the 2nd TV, select the 'Analogue' input source.
- 2) Select the channel that you wish to store the Sky box/channel on. (If you do not use channels 1-5 because you no longer have analogue terrestrial channels after digital switchover, you may choose to select channel 1 to store the Sky box/channel, if you still have and use analogue channels 1-5, you may for example decide that channel 6 is the best option for you)
- 3) Press the corresponding number on the remote control to select the desired analogue channel chosen as per point 2 above.
- 4) On the TV remote control, press Menu. Now navigate through the menus to select Manual Tuning or Analogue Manual tuning (refer to the Tuning/Channel menu section of this user guide if necessary)
- 5) Manually tune in the channel (usually, the sky box is at a frequency between 800Mhz and 850Mhz) once the Sky box/channel is found, press 'OK' to store it.

If you wish to use your Sky remote to operate the TV's functions, you will need a Sky remote control (Revision 9 or later) and you will need to programme a 4 digit code into it. See below.

Using a Sky Remote or a Universal Remote to operate your TV

Sky Remote Control, If you wish to use your Sky remote to operate the basic functions of your TV, you need to programme a 4 digit code into it. Please note. you will need the latest Sky Revision 9 remote control as this is the only version that includes the latest software/firmware necessary to operate this model of TV. All codes can be found on our website. If you wish to upgrade/replace your existing Sky remote control to the latest version, you can do so on our web site.

Universal Remote Control, If you wish to use a Universal remote control to operate your TV, please refer to the web site for a full list of codes. (Please note we only have codes for One for All branded remote controls, if you have an alternative brand of Universal remote, please refer to the manufacturer for the code.)

FREQUENTLY ASKED QUESTIONS

General	I would like to have louder sound by connecting additional speakers	Use the 3.5mm headphone output and a 3.5mm to phono cable (available separately) to connect to an amplifier/surround sound system
General	Why are some options in the menu unavailable and greyed out	Some options are only available in certain sources, i.e. HDMI. They are unavailable in the other sources where they have no affect.
TV	I have tuned in Digital TV but I am not receiving any or all of the channels and/or the channels I receive are breaking up	1) Check you are in an area that can receive Saorview. Visit www.saorview.ie . 2) Check you are using an aerial that is able to receive a good digital signal. In most cases, you will need an outdoor digital hi-gain/wideband aerial. In areas that have excellent Saorview coverage, you may be able to use a loft type aerial but it is highly likely that you will also need to connect a booster between the back of the TV and the TV aerial wall socket. Unfortunately, to receive a good enough digital signal, it is not possible to use a portable/indoor type aerial. This may change once the analogue signal is switched off in 2012 and the Digital signal strength is increased.
TV	I have re-tuned my television but when I switch it off it is not storing the channels	Complete a first time installation, please refer to the set-up menu section of the manual of how to do this
VCR/DVD Recorder	I have connected the TV to my VCR or DVD Recorder via SCART/AV but it is not recording	In addition to connecting via SCART or AV input, you should connect the aerial cable from the wall socket to your VCR/DVD Recorder and another aerial cable from the VCR/DVD Recorder to the TV
General	Can I stop my TV turning off after 4hrs?	Yes 1) In the picture settings menu, de-select Eco-home 2) In the time settings menu, scroll down to Auto standby and select OFF
Game Consoles	I have connected my PS3 to the TV via HDMI, but I am not receiving any pictures or sound on my Television	1) Ensure the TV's source is on HDMI 2) Check your settings on your PS3 are as per the PS3 instruction manual
Game Consoles	I have connected my Xbox 360 to the TV via Component Cables (Red, Green & Blue) but I am not receiving any sound	Component cables only provide HD Pictures. For the sound you will need to connect the Red & White audio cables on the Xbox to the Red & White phono inputs on the rear of the TV. Please refer to the 'Connections' pages.
USB Mode	I have inserted a USB Memory Key, but the TV does not recognise it	Ensure the USB Memory Key is formatted to type FAT32.
USB Mode	Using a USB portable hard drive	If you wish to use a portable hard drive larger than 32GB, please note that it must be formatted to the FAT32 file system in order to operate on this TV. Windows XP/Vista computers are only capable of formatting up to 32GB, therefore, you will need a software programme/utility to format larger hard drives. Please refer to the web site for more information.
System Lock	I have changed the password on the television and now forgotten it	There is a master password of 4711, to gain access to the TV menu and reset the normal password

Note: Supplier may change Software Version and On Screen Graphics without warning.

TECHNICAL SPECIFICATION

Model	19-248COMI	22-248COMI	24-E242COMI
Screen size (diagonal)	18.5"/47cm	21.5"/55cm	23.6"/60cm
Resolution	1366 x 768	1920 x 1080	1920 x 1080
Contrast Ratio	1000:1	1000:1	1000:1
Brightness cd/m ²	250 cd/m ²	250 cd/m ²	280 cd/m ²
RF	75 ohm Antenna / PAL-SECAM		
Video Inputs	1 x Scart, 1 x mini video, 1 x mini component (YPbPr - 1080P), 2 x HDMI (up to 1080P)		
Sound Inputs	1 x 3.5 mini AV - Audio input shared for Video&Component(YPbPr)		
Sound Outputs	1 x Headphone output, 1 x Coax output		
Sound power, watts (RMS)	2 x 3		
Voltage and power consumption	110 - 240V ~ 50/60Hz 18W/45W (ecomode/ max) / <0,5W in StandBy	110 - 240V ~ 50/60Hz 21/50W (ecomode/ max) (standby less than 0.5w)	110 - 240V ~ 50/60Hz 25/50W (ecomode/ max) (standby less than 0.5w)
Dimensions including stand (mm)	457W x 360H x 170D	530W x 395H x 170D	583W x 410H x 195D
Net weight (Kgs)	3.6	4.0	4.7

Compatible files in USB Mode

Media	File Ext.	Codec		
		Video	Audio	
Movie	.mpg	Mpeg-1, Mpeg-2	MP3, WMA	Max Resolution: 1920x1080 Max Data rate: 40Mbps
	.avi	Xvid, MJPEG, MPEG-4 SP/ASP		
	.ts	Mpeg-2		Max Resolution: 1920x1080 Max Data rate: 40Mbps
	.mov	Mpeg-4 SP/ASP		
	.dat	Mpeg-1		Max Resolution: 1024x768 Max Data rate: 40Mbps
	.mp4	Mpeg-1, Mpeg-2		
	.vob	Mpeg-2		
Music	.mp3	-	MP3	Sample Rate 16K-48KHz Bit rate: 320Kbps
	.wma	-	WMA	
Picture	.jpg	Progressive JPEG		Max Resolution: 1024x768
	.jpeg	Baseline JPEG		Max Resolution: 8192x8192
	.bmp	BMP		Max Resolution: 6500x6500

INDEX

Aspect Ratio.....	21	TV buttons	12
Auto Tuning.....	16	TV Guide.....	24
Auto Volume Level	18	USB Mode / Media Player	25
Balance	18	Using the television as a computer monitor	22
Bass	18	Wall mounting	9
Blue Screen	21	What is included in the box	8
Brightness	17		
Clock.....	19		
Colour	17		
Colour Temperature	17		
Common Interface	20		
Connections.....	14-15		
Contrast	17		
Detaching the base/stand.....	9		
Digital Output	18		
First Time Installation	11		
Frequently Asked Questions.....	27		
Getting Started.....	11		
Language	21		
Manual Search.....	16		
Noise Reduction	17		
Operating the TV with a universal or Sky (BSKYB) remote control	26		
Picture Mode	17		
Remote control	13		
Reset to default.....	21		
Sharpness	17		
Sleep Timer	20		
Sound Mode	18		
Source Menu.....	12		
System Lock	20		
Technical Specifications	28		
Treble	18		

